

Enterprise IP Solutions

OfficeServ™

ITP-5021D User Guide

TABLE OF CONTENTS

<u>ABOUT THIS BOOK</u>	1
<u>THINGS YOU SHOULD KNOW</u>	2-7
<u>ASSEMBLING YOUR KEYSET</u>	8
<u>ITP-5021D SETUP</u>	9-15
<u>OUTSIDE CALLS</u>	
<u>Making an Outside Call</u>	16
<u>Answering an Outside Call</u>	16
<u>Universal Answer</u>	16
<u>Recall/Flash</u>	17
<u>Busy Line Queuing with Callback</u>	17
<u>Canceling Callback</u>	17
<u>INTERCOM CALLS</u>	
<u>Calling Other Stations</u>	18
<u>Answering Intercom Calls</u>	18
<u>Answer Modes</u>	18
<u>Busy Station Callback</u>	19
<u>Busy Station Camp-on</u>	19
<u>Calling Your System Operator</u>	20
<u>CALL PROCESSING</u>	
<u>Holding Calls</u>	21-22
<u>Transferring Calls</u>	22-23
<u>Transfer with Camp-On</u>	23
<u>Transfer to Voice Mail</u>	23
<u>Call Waiting</u>	23
<u>Conference Calls</u>	24
<u>Forwarding Calls</u>	25-26
<u>Call Pickup</u>	27
<u>My Group Pickup</u>	27
<u>Privacy Release</u>	27-28

Copyright 2004 Samsung Telecommunications America.

All rights reserved. No part of this manual may be reproduced in any form or by any means—graphic, electronic or mechanical, including recording, taping, photocopying or information retrieval systems—without express written permission of the publisher of this material.

Samsung Telecommunications America reserves the right without prior notice to revise information in this guide for any reason. Samsung Telecommunications America also reserves the right without prior notice to make changes in design or components of equipment as engineering and manufacturing may warrant. Samsung Telecommunications America disclaims all liabilities for damages arising from the erroneous interpretation or use of information presented in this guide.

DIALING FEATURES

Speed Dialing	29
Programming Personal Speed Dial Numbers	29–30
One Touch Speed Dialing	30
Last Number Redial	30
Manual Retry with Redial	31
Save Number with Redial	31
Chain Dialing	31
Automatic Redial/Retry	31
Pulse to Tone Changeover	32
Memo Redialing	32

PAGING AND MESSAGING

Making an Internal Page	33
Making an External Page	33
All Page	33
Meet Me Page	34
Call Park and Page	34
Messages—Set and Cancel	35
Returning Messages	35
Programmed Messages	36

CONVENIENCE FEATURES

Do Not Disturb	37
One Time DND	37
Mute	37
Background Music	37
Established Call Pick-Up	38
Appointment Reminder/Alarm Clock	38
Door Phone Calls	39
Executive/Secretary Hotline	39
Group Listening	40
Account Codes	40
Locking Your Keypad	40
Manual Signalling	41
Off-Hook Voice Announce	41
OHVA Block	42
OHVA Reject	42
In Group/Out of Group	42

CUSTOMIZING YOUR KEYSSET

AME Password	43
Auto Camp-On	43
Select Ring Tone	43
Change Your Passcode	43
Set Answer Mode (Intercom)	44
Set Answer Mode (CO)	44
Automatic Hold	44
Headset Operation	44
Hot Keypad	45
Key Confirmation Tone	45
Rejoining a Page	45
Ring Preference	45
Auto Answer CO Calls	46
Display Speed Dial Name	46
Caller ID Review All	46
Secure OHVA	46
Enblock Dialing	47

DISPLAY FEATURES

Interactive Display Keys	48
Directory Information	48
Call Log	49
Dial by Name	49
Call Progress Displays	50
Display Number Dialed	50
Call Duration Timer	50
Auto Timer	50
Timer Function	50
Viewing Message Indications	51
Alarm Reminder Messages	51–52
Personal Speed Dial Names	52
Station Names	52
Managing Key Assignments	53
LCR with Clear	53
Backspace with LCR	53
Text Messaging	54–55
Caller ID	56–60
ANI	57–60
CLI	57–60

SPECIAL APPLICATION MENU	61
Menu Options	61–63
Outgoing Call Log	61
Incoming Call Log	61
Speed Dial	62
Directory Dial	62
Forward Set	62
Alarm Reminder	62
SVMi-8 / SVMi-16E	64
Accessing your Mailbox	65
SVMi-8/SVMi-16E Subscriber Services Menu Diagram	66–67
Getting Started	68
Listen to your Messages	68
Subscriber Services Menu	68
Listening to Old or New Messages	69
Group New or Old Messages	70
Record and Send a Message	70–71
Access Manager	71
Personal Greetings	73
Mailbox Administration	75
Message Broadcast	77
Personal Services	78
Personal Administration Settings	79
Keypad User Features	80
Shortcuts	82
Interactive Displays	82
PERSONAL SPEED DIAL NUMBERS	83–84

ABOUT THIS BOOK

Samsung's new OfficeServ Technology keyset model, ITP-5021D, is part of the iDCS 500 Release 2.

The ITP-5021D IP keyset represents a new concept of Internet phone, in that it uses an IP address to Send/Receive voice and data. For voice communications, the ITP-5021D uses the data network line already in place in most offices and increasing number of homes.

The ITP-5021D keysets incorporate an LCD screen, which provides important information for the user, to make using the keyset easier and more convenient.

Your keyset is the most visible part of your telephone system. Please take the time to study this guide and to become familiar with the operation of your keyset. Keep this guide handy, as you may need to look up instructions for infrequently used features.

Learning to use your keyset correctly will make everyday telephone communications a breeze.

This book is written based on the factory default settings for the feature access codes. Sometimes, due to programming requirements, these codes may be changed. If you find that a feature code does not work as described in this book, please contact your installation and service company to determine the correct code.

THINGS YOU SHOULD KNOW

USER ORIENTATION

The ITP model telephones are called IP keysets. The IP keyset incorporates buttons or “keys” that are used to access or activate the many features of your office phone system. The ITP-5021D keyset incorporates 21 programmable buttons. These 21 buttons are arranged in three rows of seven across the face of the keyset. Any of the system features or functions can be programmed to these buttons.

The three buttons above the top row of programmable buttons are soft keys. These buttons assist in the use of the system features and functions.

Lines from the telephone company are “C.O. lines.” Calls on these lines are referred to as “outside calls.” Your system can have individual C.O. line keys or lines may be assigned to groups. When they are in a group, you access a line by dialing an access code or pressing a route button. For example, dial 9 or press a “LOCAL” button to get a local outside line. If Least Cost Routing is used, pressing the “LCR” button will automatically select a preprogrammed C.O. line according to what digits are dialed. Each line in the system is numbered, beginning with 701, then 702, 703, etc.

Direct Station Selection (DSS) buttons are programmed to ring specific stations. You can press a DSS button instead of dialing the extension number.

CALL INDICATIONS

The buttons on your phone have light emitting diodes (LEDs). These are tri-colored LEDs that light green, red or amber (green and red together).

Intercom calls, also called internal calls, always appear on your CALL buttons. They will always light green. You can have up to eight CALL buttons, but at least two are recommended.

Outside calls appear on individual line buttons if they are assigned. When an individual line is not assigned to its own button, it will appear on a CALL button.

Your outside calls will light green on your keyset and red on other keysets. You never lose sight of your calls while they are on hold. They stay right where you put them and are identified with a green flashing light.

Some simple rules to remember:

- Any steady LED indicates the line or feature is in use.
- A fast flashing green LED indicates a new call ringing in.
- A slow flashing green or red LED indicates a call is on hold.
- A slow flashing amber LED indicates a recall to your keyset.

SPEAKERPHONE

All ITP keysets are speakerphones. Pressing the **SEND** button will answer an incoming call on the speakerphone. Pressing the **END** button will release the call on the speakerphone.

Switching from the handset to the speakerphone is easy. Simply press the **SPEAKER** button and hang up the handset.

VOLUME CONTROLS

The ITP-5021D keyset uses the **UP** and **DOWN** buttons to adjust the ringer volume while the keyset is ringing, the speaker volume while the speakerphone is in use and the handset volume while you are listening. These three levels will be stored in memory until changed. If background music is turned on at your keyset, the volume buttons will also control the level of music. The volume of pages heard through the speaker of a keyset can be adjusted during a page announcement by using the volume buttons. There are 16 levels for each volume setting. The volume of off-hook ring is controlled by a user-programmable setting.

TERMINAL STATUS INDICATOR

The terminal status indicator light is positioned on the top right corner of the keyset above the display. The terminal status indicator is a tri-colored (red, green, and amber) light that provides greater visibility of your keysets status than the individual button LEDs. The terminal status indicator provides the following indications:

- | | |
|---------------------|--------------------------------------|
| • Busy/Off Hook | Steady Red |
| • Intercom Ring | Flashing Red |
| • Outside Call Ring | Flashing Green |
| • Recall Ring | Flashing Amber |
| • Message Waiting | Flashing Red |
| • Do Not Disturb | Fast Flash Red at 1 Second Intervals |

CONFERENCE BUTTON

The **CONFERENCE** button allows the user to set up a call with up to 5 parties (station or trunk).

TRANSFER BUTTON

Transfer is used to send any call to another extension in one of two ways. You can do a screened transfer by informing the other extension who is calling or you can do a blind transfer without notification.

HOLD BUTTON

The **HOLD** button maintains the call at your keyset, while enabling you to call other stations or consult coworkers in confidence.

SPEAKER BUTTON

The **SPEAKER** button allows you to have a conversation from the keyset without lifting the handset.

NAVIGATION BUTTON

The ITP-5021D keyset incorporates a **NAVIGATION** button. This button is designed to assist the user in activating and using various station features, more easily. These features include:

- Outgoing Call Log
- Incoming Call Log
- Speed Number Search
- Name Search
- Call Forward Assign
- Alarm Assign

With the **NAVIGATION** button the station user is no longer required to enter station level programming to activate these frequently used features. A few button presses and these features are activated.

The **NAVIGATION** button is divided into separate feature buttons. These buttons are described below.

- **MENU BUTTON:** This button displays the station feature main menu so that the users can easily utilize various settings and helpful functions.

- **SEND BUTTON:** If the station is programmed for **Enblok Dial Mode**, when dialing an outside telephone number or internal station number, you must press the **SEND** button to initiate the call. This button is also used when reviewing recently received or called numbers and answering incoming calls.

When reviewing recently received calls, continue to press the **SEND** button for more than 2 seconds and the last outside number called will be redialed.

The **SEND** button operates as the **ANS** portion of the **ANS/RLS** button. An **ANS/RLS** button may be assigned to the station as a programmable button.

- **ENTER BUTTON:** This button is used to select a menu option, or to save changes made to a menu or submenu option.
- **DIRECTION BUTTON:** The **DIRECTION BUTTON** is the donut shaped ring, which surrounds the **ENTER** button. This button is used to navigate within the menus. There are directional arrows stenciled into this button, which indicate which direction the cursor will be moved.
- **END BUTTON:** This button is used to disconnect a call after a conversation or to move to the initial screen.
The **END** button operates as the **RLS** portion of the **ANS/RLS** button. An **ANS/RLS** button may be assigned to the station as a programmable button.
- **CANCEL BUTTON:** This button is used to erase any characters or numbers entered by the dial pad or to move to the previous screen.

FEATURE ACCESS CODES

This user guide is written based on the default access code for using system features. If the system numbering plan has been changed some of the access codes may not be correct. Your installing company can inform you of the correct codes.

SYSTEM TONES

The system provides several tones to assist you. Some of these tones are already familiar to you.

Intercom Dial Tone—A steady tone that indicates you can begin dialing.

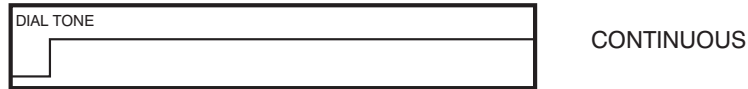

Ringback Tone—Indicates the station you dialed is ringing.

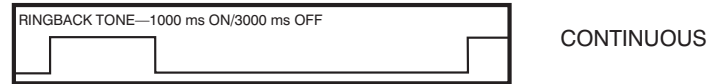

Busy Tone—Indicates the station you dialed is busy.



DND/No More Calls Tone—Fast busy tone indicates the station you dialed is in the Do Not Disturb mode or cannot receive any more calls.

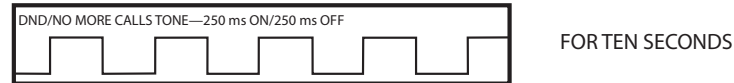

Transfer/Conference Tone—Indicates your call is being held and you can dial another party.

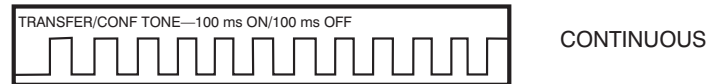

Confirmation Tone—Very short beeps followed by dial tone indicate you have correctly set or canceled a system feature.

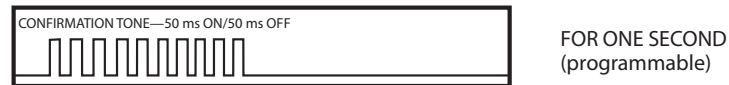

Error Tone—A distinctive two level beeping tone indicates you have done something incorrectly. Try again.



ITP-5021D

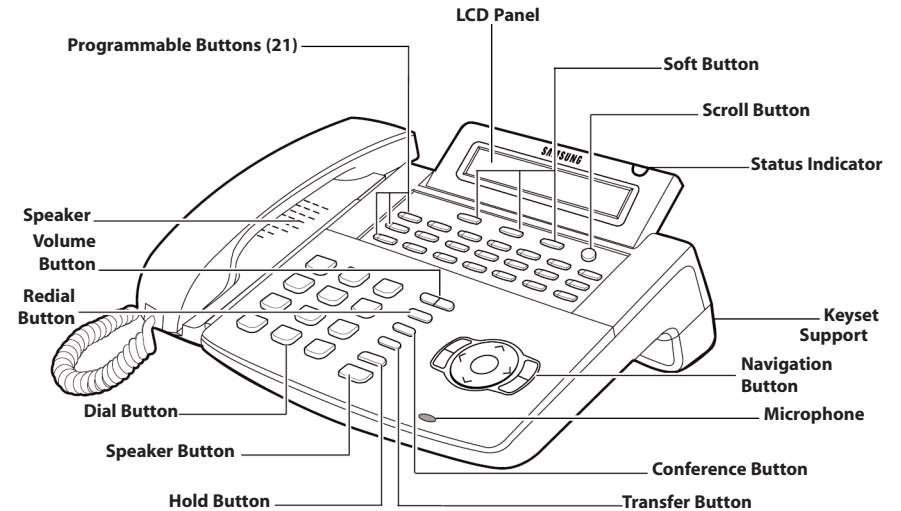

ASSEMBLING YOUR KEYSET

- Place the keyset face down on a flat surface.
- Insert notched ends of the support bracket into the channels located in the upper section of the bottom panel. Push towards the top of the keyset to lock in.
- Plug the handset cord into the jack marked with the  symbol.
- Route the handset cord out the **RIGHT** side of the keyset as you look at it face down.
- Plug the eight-conductor **LAN** cable, from the wall, into the jack marked **LAN** on the back of the keyset. (Connect the ITP keyset to any port on the local network).
- Plug the eight-conductor **PC** cable, from the PC, into the jack marked **PC** on the back of the keyset.
- Plug the power connector, from the power adapter provided, into the power jack on the back of the keyset.

IMPORTANT NOTE:

- Be careful not to connect the Network LAN cable into the PC connector of the phone.
- To prevent damaging the keyset, only use the Power Adapter that came with the 5021D keyset.
- This manual assumes that the ITP keysets are connected to a functioning local IP network. The local IP network must be able to communicate with the MCP2 and MGI card in the iDCS 500 system over IP. This is assumed regardless of whether the IP keyset is on a local or remote network.

ITP-5021D SETUP

INITIALIZING THE ITP-5021D

Initially the ITP-5021D IP keyset will need to be setup to operate within the users network. The Setup Menu is also used to make changes to the keyset, in the event that the system information should change. The option chosen via scroll key will be highlighted.

The station numbers will be automatically set by the iDCS 500 system once the necessary information has been entered into the IP keyset. Enter ID and password of the server, as described below to register the phone.

See your system administrator for specific Network and Server addresses. The addresses necessary to set up the ITP-5021D are:

- IP Address of Station
- Network Gateway Address of Station
- Subnet Mask
- iDCS 500 MCP2 Server Address
- User ID

To get to the Set-Up Menu, unplug the power from the ITP-5021D phone, press and hold the **MENU** button while plugging in the power cord back into the phone. Now release the **MENU** button.

```
>1. Information  
  2. Network
```

Other items not shown on screen:

```
3. Load & Upgrade  
4. System
```

```
5. Server  
6. Exit
```

IP SETUP MENU

To enter the **IP SETUP MENU**, press the **MENU** button as soon as the ITP-5021D phone is connected to the power supply.

When entering the IP setup menu, the LCD displays the following options:

```
>1. Infomation
2. Network
```

Other items not shown on screen:

```
3. Load & Upgrade
4. System
```

```
5. Server
6. Exit
```

Once the **IP SETUP MENU** is displayed, you can move to each menu in the Set Up by using the navigation buttons or the **[1]-[9]** dial buttons of the ITP-5021D IP phone.

- The **UP** and **DOWN** directions buttons in the navigation button assembly are used to move the highlighted bar up or down to the desired option.
- The **LEFT** and **RIGHT** buttons in the navigation button assembly are used to move the highlighted bar left or right, to the desired option, move to a sub menu and if a menu is at the last line, that menu option will be executed.
- The **[0]-[9]** dial buttons are used to directly choose a menu, or sub menu options.
- The **[ENTER]** button in the navigation button assembly is used when saving a modification.
- The **[MENU]** button in the navigation button assembly is used to to display the IP Setup Main Menu.
- The **[END]** button in the navigation button assembly is used when canceling or editing the modification, or existing programming.
- The **[CANCEL]** button in the navigation button assembly is used to go back to the previous screen or to delete the last digit of a displayed option value.

MENU STRUCTURE

The IP SETUP MENU is configured as follows:

1. INFORMATION

1. Version
2. Network
3. Load Option
4. MAC Address

2. NETWORK

1. Mode
2. IP
3. Netmask
4. Gateway

Note that items 2 to 4 are only displayed when setting Manual IP.

3. LOAD & UPGRADE

1. Load Option
2. Upgrade Program
3. Upgrade Bootrom
4. Format

4. SYSTEM

1. Password

5. SERVER

1. Server IP
2. ID
3. Password

6. EXIT

NAVIGATING THE MENUS

When programming within various menu options, information can be entered via the dial pad keys using [0]-[9] and [*] dial keys, as well as utilizing the navigation button assembly.

The button used for editing and their features are summarized below.

BUTTON	FEATURES
Left and Right	To move a cursor (highlighted area) or to erase what is entered.
Enter	To save the current setting and end programming.
End.....	To cancel the current programming and return to the Main Menu.
Cancel.....	To move back to the previous screen or delete the last digit of the displayed option value.
[*]	To enter [,] between IP address fields.
[0]-[9]	To enter numerical values.

SETTING THE NETWORK PARAMETERS

Utilize the following programming steps to program the ITP-5021D keyset to operate within the users network.

Network Parameter Setup

From the Setup, Main Menu, select [2. Network] to set or modify the network parameters.

```
>1.Mode
```

Press **ENTER**, the LCD will display this message.

```
>1.Manual IP
2.DHCP
```

- If [1. Manual IP] is selected, the user must enter the IP address of the IP keyset. Then enter the subnet mask, and gateway value for the customer network.
- If [2. DHCP] is selected, the IP address, subnet mask, and gateway value will be obtained automatically (if a DHCP server is present).

Setting IP Manually

- If [1. Manual IP] is selected, press **ENTER** and this sub menu will be displayed on the LCD.

```
>1.Mode
2.IP
```

Items not visible in the first screen:

```
3.Netmask
4.Gateway
```

Enter the IP address of the IP keyset. Next, enter the netmask and gateway address for the customer network.

- If the [2. IP] menu is selected, press **ENTER**, the LCD will display this message and the user can enter its IP address.

```
Input IP Address
xxx.xxx.xxx.xxx
```

Check if there is any currently saved IP address of the phone on the LCD. If the IP address has not been set, the LCD displays nothing. The user can enter the IP address using [0]-[9] dial buttons and [*] button can save that IP address by pressing the [Enter] button of navigation button assembly.

- If the [3. Netmask] menu is selected, press **ENTER**, the LCD will display the following message and the user can enter a new Netmask IP address.

```
Input Netmask
xxx.xxx.xxx.xxx
```

Check if there is any currently saved subnet mask address of the phone on the LCD. If the subnet mask address has not been set, the display will show nothing. Press any dial buttons from [0]-[9] and [*] button to enter the subnet mask IP address and then save that subnet mask IP address by pressing the [Enter] button of navigation button assembly.

- If the [4. Gateway] menu is selected, press **ENTER**, the LCD will display the following message and the user can enter a new gateway address.

```
Input Def. Gateway
xxx.xxx.xxx.xxx
```

Check if there is any currently saved Gateway IP address of the phone on the LCD. If the gateway IP address has not been set, the LCD displays nothing. The user can enter the gateway IP address by using [0]-[9] and [*] button and can save that IP address by pressing the **ENTER** button of the navigation button assembly.

NOTE: In the [2. Network Menu], [1. Mode] option, when [2. DHCP] is selected the IP address, Netmask, and Gateway will not be displayed on the LCD.

Load and Upgrade Set/Modify

The third item [**3. Load & Upgrade**] sets or modifies the IP phone's software version. Use extreme caution when upgrading the keyset.

Select the [**3. Load & Upgrade**] item and move to the lower level. The screen below is displayed.

1. Load Option
2. Upgrade Program

Item not visible in the first screen:

3. Upgrade Bootrom
4. Format

In the [**1. Load Option**] item, move to the lower level and select [**2. File System**].

Each of the items [2. Upgrade Program] and [3. Upgrade Bootrom] are used for upgrading program and bootrom. Set the IP of the TFTP server you wish to upgrade and press OK.

The [**4. Format**] item is used for deleting all programs and data except bootrom.

CAUTION: For engineering purposes only. The format option should not be used unless instructed by an Authorized Samsung Engineering or Technical Support Representative.

Authentication Server Related Set/Modify

The fifth item [**5. Server**] sets or modifies settings related to the authentication server. Select the [5. Server] item and move to the lower level. The screen below is displayed.

1. Server IP

You can set/modify the IP address of the authentication server at the [1. Server IP] item. The screen below is displayed when you enter the item. The server IP is the IP address of the MCP2.

Input ServerIP
xxx.xxx.xxx.xxx

You can confirm the current IP address of the authentication server at the LCD panel. The address is left blank if it is not set. Use the dial buttons from [0]-[9], and [*] to set the IP address and press the [ENTER] button among the navigation buttons to save and exit.

* Input Id
xxxx

You must input the ID assigned to your ITP phone. See your phone system administrator to get this value. Press the [ENTER] button to save and exit.

* Input Password
xxxx

You must input the password associated with your ID. See your phone system administrator to get this value. Press the [ENTER] button to save and exit.

Completion of Settings

Verify settings at the first item [1. Information] after setting all of the above items. Select the sixth item [6. Exit] to save all modified settings and reboot the ITP-5021D phone.

OUTSIDE CALLS

MAKING AN OUTSIDE CALL

- Lift the handset and press an idle outside line button, line group button or dial a line access code to receive dial tone—**OR**—press an idle outside line button, line group button or dial a line access code to receive dial tone through the speaker—**OR**—press **SPEAKER**, receive intercom dial tone and dial a line access code.
- Dial the telephone number.
- Finish the call by replacing the handset or pressing the **END** button.

NOTE: You will receive No More Calls tone when you attempt to make a call and there is no button available for that line.

- If Least Cost Routing is enabled on your phone system, this button may be labeled **LCR** or accessed by dialing an access code (usually **9**).
- If your system is programmed to require an authorization code before making a call, dial ***** plus a valid code before selecting a C.O. line.
- If your system is programmed to require an account code before making a call, press the **ACC** button or dial **47** plus a valid bin number, press the **ACC** button again and then select a C.O. line. [See Account Codes for more information.](#)

For more information on authorization and account codes, see your system administrator.

NOTE: If the Hot Keypad feature has been turned off, you must first lift the handset or press the **SPEAKER** button before dialing.

ANSWERING AN OUTSIDE CALL

- Lift the handset and you are automatically connected to the ringing call. [See Ring Preference under Customizing Your Keypad](#)—**OR**—press the **SEND** button to automatically answer on the speakerphone.

NOTE: If a call is flashing at your keyset but not ringing, you must press the flashing button to answer.

UNIVERSAL ANSWER

Outside lines may be programmed to ring a general alerting device. To answer calls ringing this device, dial **67** or press the **UA** button. This device can operate in any one of the six different ring plans.

NOTE: If the Hot Keypad feature has been turned off, you must first lift the handset or press the **SPEAKER** button before dialing.

RECALL DIAL TONE

Press the **NEW** button to disconnect your existing call, wait for dial tone and then make a new call on the same line.

NOTE: If this button does not appear on your keyset, the **FLASH** button may be programmed to recall dial tone.

SENDING A FLASH

While on an outside call, press the **FLASH** button to send a flash to the telephone company. This is required for some custom calling features or CENTREX use.

NOTE: Flash is not available on an ISDN circuit.

BUSY LINE QUEUING WITH CALLBACK

If you receive a busy signal when you are selecting an outside line, this means that the line or group of lines is busy.

- Press the **CBK** button, if programmed, or dial **44**. You will hear confirmation tone.
- When the line becomes free, the system will call you back.
- Lift the handset or press the **SEND** button to answer, wait for dial tone and dial the telephone number or speed dial number again.

NOTES:

1. A callback will be canceled if not answered within 30 seconds. If you have set a callback, your **CBK** button will light.
2. If the Hot Keypad feature has been turned off, you must first lift the handset or press the **SPEAKER** button before dialing.

CANCELING CALLBACK

A callback will be canceled if not answered within 30 seconds. If you have set a callback, your **CBK** button will light.

Your phone may have a maximum of five callbacks to lines and/or stations set at a time. To cancel a callback:

- Press the **CBK** button, if programmed, or dial **44**. You will hear confirmation tone.
- While you are listening to confirmation tone, press the **HOLD** button. This will cancel the oldest set callback.

NOTE: If the hot keypad feature is turned off, you must first lift the handset or press the **SPEAKER** button before dialing.

INTERCOM CALLS

CALLING OTHER STATIONS

- Dial the extension number or group number.
- Wait for the party to answer. If you hear a brief tone burst instead of ringback tone, the station you called is set for Voice Announce or Auto Answer. Begin speaking immediately after the tone.
- Finish the call by replacing the handset or press the **END** button.

NOTES:

1. If you have a **DSS** button assigned to an extension or station group, you may press this button instead of dialing the number.
2. If the Hot Keypad feature has been turned off, you must first lift the handset or press the **SPEAKER** button before you begin dialing.

ANSWERING INTERCOM CALLS

- When your keyset rings, simply lift the handset—**OR**—press the **SEND** button to be connected to the calling station.
- To finish the call, replace the handset or press the **END** button.

[See Ring Preference under Customizing Your Keypad.](#)

VOICE ANNOUNCE MODE

When another station calls you, your keyset will sound a brief attention tone and you will hear the caller's announcement.

- Press **SEND** to turn on the microphone and speak handsfree—**OR**— lift the handset to reply.
- To finish the call, replace the handset or press the **END** button.

NOTE: In order for C.O. calls to be answered handsfree, AUTO ANS CO must be set ON.

AUTO ANSWER MODE

When another station calls you, your keyset will sound a brief attention tone and then automatically answer the call.

- Your microphone and speaker are turned on and you can speak handsfree. For privacy, use the handset.
- To finish the call, replace the handset or press the **END** button.

NOTE: In order for C.O. calls to be answered handsfree, AUTO ANS CO must be set ON.

BUSY STATION CALLBACK

When you call another station and receive a busy signal:

- Press the **CBK** button, if programmed, or dial **44**.
- When the busy station becomes free, your keyset will ring.
- Lift the handset or press **SEND** to call the now idle station.

NOTES:

1. A callback will be canceled if not answered within 30 seconds. If you have set a callback, your **CBK** button will light.
2. If the Hot Keypad feature has been turned off, you must first lift the handset or press the **SPEAKER** button before dialing.

BUSY STATION CAMP-ON

When you call another station and receive a busy signal but you do not want to wait for a callback:

MANUAL CAMP-ON

- Press the **CAMP** button or dial **45**.
- The called station will receive off-hook ring tone repeated every few seconds and its first available **CALL** button will flash green to indicate your call is waiting.
- Wait for the called party to answer.
- The called station must release its first call or place it on hold before answering your camp-on.

NOTES:

1. If you receive No More Calls tone, that station has no available button to accept your call. Hang up or leave a message.
2. If the Hot Keypad feature has been turned off, you must first lift the handset or press the **SPEAKER** button before dialing.

AUTO CAMP-ON

When you want to automatically camp on to a busy station without pressing the camp on button every time you call a busy station, you can set your phone for auto camp-on.

- With the handset on-hook, press **TRANSFER** and then dial **110**.
- Dial **081** to turn on auto camp-on or **080** to turn it off.
- Press **TRANSFER** to store your selection.

CALLING YOUR SYSTEM OPERATOR

- Dial **0** to call your system operator or group of operators.
- If you want to call a specific operator, dial that person's extension number.

NOTE: If the Hot Keypad feature has been turned off, you must first lift the handset or press the **SPEAKER** button before you begin dialing.

CALL PROCESSING

SYSTEM HOLD

- When you are connected to any call, press **HOLD**. The call will flash green at your keyset. If this call appears on a line button at other keysets, it will flash red at those keysets.
- To take the caller off hold, press that button and the green flashing light will go steady green again. Resume the conversation.

NOTE: While on a call, pressing a line button, route button or flashing **CALL** button will automatically put your first call on hold and connect you to the new call. See *Automatic Hold* under *Customizing Your Keypad*.

EXCLUSIVE HOLD

To place an outside call on hold at your phone so that other users cannot get it:

- Press the **HOLD** button twice. The call will flash green on your keyset and this line will show a steady red light on other keysets.
- To retrieve the call, press the flashing green line button or press the **HOLD** button a third time.

NOTE: Intercom calls will always be placed on exclusive hold.

REMOTE HOLD

When you wish to place a call on hold at another station. Press **TRANSFER** and dial the station number (or press the appropriate DSS button). Press the **HOLD** button. This will place the call on system hold on an available CALL button or Line Button at the remote station and return you to dial tone.

NOTES:

1. If the destination station does not have any free CALL buttons or line buttons you will hear No More Calls tone and must return to the other party by pressing the **TRANSFER** button (or the RETURN soft key in the display).
2. Intercom calls cannot be remote held.

HOLD RECALL

If you leave a call on hold longer than the hold timer, it will recall your station. The button that the call appears on will have a slow flashing amber light.

- When your phone rings, lift the handset or press the **SEND** button to answer the recall.

- If you do not answer this recall within a pre-programmed period of time, it will go to the system operator.

CONSULTATION HOLD

When you are talking on an outside line and it is necessary to consult with another extension:

- Press the **TRANSFER** button; you will receive transfer dial tone. Your call is placed on transfer hold.
- Dial the extension number.
- Consult with the internal party.
- Press **TRANSFER** to return to the outside party or hang up to transfer the call.

NOTE: Repeatedly pressing the **TRANSFER** button will toggle between the outside party and internal extension. If necessary you may disconnect either one of the parties by pressing the **DROP** button.

RETRIEVING CALLS HELD AT ANOTHER STATION

When a line is on hold and it appears on your keyset, press the line button with the red flashing light.

When a line is on hold and it does not appear on your keyset, dial **12** plus the line number or the extension number of the station that placed the call on hold.

NOTE: If the Hot Keypad feature has been turned off, you must first lift the handset or press the **SPEAKER** button before you begin dialing.

TRANSFERRING CALLS

Transfer is used to send any call to another extension in one of two ways. You can do a screened transfer by informing the other extension who is calling or you can do a blind transfer without notification.

- While on a call, press the **TRANSFER** button and dial an extension number or group number. Your call is automatically put on transfer hold. **OR** Press a **DSS** button or station group button. Your call is automatically put on transfer hold.
- Hang up when you hear ringing (this is an unscreened or blind transfer). **OR** Wait for the called party to answer and advise him/her of the call and hang up. If the transfer is refused, you will be reconnected to the outside line when the called station hangs up or you can press **TRANSFER** to return to the outside party. If you wish to send the call to another extension without waiting for the

first station to hang up, simply press another **DSS** button. **OR** Press the **CALL** button or C.O. line button to return to the outside party and begin the transfer process again.

When you are transferring a call to a keyset set for Voice Announce or Auto Answer, the transferred call will always ring.

NOTES:

1. After the inside party answers, you may alternate back and forth between the parties by pressing the **TRANSFER** button.
2. If you receive No More Calls tone, that station has no button available to receive another call. Press **TRANSFER** to return to the other party.
3. You cannot transfer an Intercom call by pressing a DSS button. You must press the **TRANSFER** button and dial the destination extension number.

TRANSFER WITH CAMP-ON

When you are transferring a call to another station and you receive a busy signal, you may camp the call on to this station. Simply hang up when you hear the busy signal. The called party will be alerted that a call is waiting for them.

NOTE: If you receive No More Calls tone, that station has no button available to receive another call. Press **TRANSFER** to return to the outside caller.

TRANSFER TO VOICE MAIL

This feature is used to send a call directly to a voice mailbox. Your keyset must have a correctly programmed **VT** button to accomplish this. To transfer a call directly to a voice mailbox:

- While on a call, press the **VT** button and dial the mailbox number.
- Hang up when dialing is completed.

NOTE: The **VT** button will not work with a Centralized Voice Mail in a Network System.

CALL WAITING

If an outside call has been camped-on to your phone or another station has camped-on to you:

- Your keyset will ring and the call that is waiting for you (camped-on) will flash green.
- Press the flashing button to answer; your other call will go on hold automatically if your station has the Automatic Hold feature set. If not, you must press **HOLD** and then the flashing button. **OR** Finish the first call and hang up; the waiting call will ring.

- Lift the handset or press the **SEND** or **ANS/RLS** button to answer.

NOTE: Intercom calls will not go on Automatic Hold.

CONFERENCE CALLS

You may conference up to five parties (you and four others) in any combination of outside lines and internal stations in any order.

- While engaged in a conversation, press the **CONF** button and receive conference tone.
- Make another call, either intercom or outside, press the **CONF** button and receive conference tone.
- Make another call or press the **CONF** button to join all parties.
- Repeat the last step until all parties are added.

NOTE: When attempting to add another party to the conference and you are not able to reach the desired person, hang up. Simply press the **CONF** button again to return to your previous conversation.

To drop a party from your conference call:

- Press **CONF** and dial the extension or line number that is to be dropped.
- Press **CONF** again to reestablish the conference.

NOTE: To leave the conference, hang up. Control is passed to the next internal station. If there are no internal stations and you wish to leave outside lines connected together in a trunk to trunk conference, press the **CONF** button plus the **CALL** button that the call appears on or follow the instructions to drop a party and use your extension number. When they hang up, the lines will release automatically. Press **CONF** to rejoin a trunk to trunk conference.

CONFERENCE SPLITTING

If you are the controlling party of a conference and your keyset has the Auto Hold feature turned on ([See Customizing Your Keyset](#)) and all of the outside lines involved in the conference appear as buttons on your keyset, you can split the conference into separate calls as follows:

- Press any one of the outside line buttons. That outside line will remain steady green to indicate you are still connected to it. All other outside lines in the conference will be placed on system hold at your keyset. All intercom callers in the conference will be disconnected. You may now speak with each caller privately and transfer them as usual or reestablish another conference.

FORWARDING CALLS

You may forward your calls to another station, group of stations or an external telephone number. Program a destination for the type of forwarding you want as detailed below. If you have **FWD ALL**, **FWD BUSY** and **FWD NO ANSWER** buttons, press one to turn that forward feature on. A steady red light reminds you what forward condition is activated.

You can clear all call forward conditions set at your station by lifting the handset and dialing **600**.

FORWARD ALL CALLS

To forward all your calls under any condition to another station:

- Dial **601** plus the extension or group number.
- Receive confirmation tone and hang up.

NOTES:

1. If the Hot Keypad feature has been turned off, you must first lift the handset or press the **SPEAKER** button before you begin dialing.
2. The station that receives a Forwarded All call can transfer the call to the forwarded station. This is useful when you are expecting an important call but you do not wish to be disturbed by other calls.
3. When a station user places his/her keyset in Forward All mode and he/she does not have a **FORWARD ALL** button, the **TRANSFER** button will light to indicate Forward All has been set and calls to this station have been transferred elsewhere.

FORWARD BUSY

To forward calls to another station when you are on the phone:

- Dial **602** plus the extension or group number.
- Receive confirmation tone and hang up.

NOTE: If the Hot Keypad feature has been turned off, you must first lift the handset or press **SPEAKER** before you begin dialing.

FORWARD NO ANSWER

To forward calls to another station when you do not answer:

- Dial **603** plus the extension or group number.
- Receive confirmation tone and hang up.

NOTE: If the Hot Keypad feature has been turned off, you must first lift the handset or press the **SPEAKER** button before you begin dialing.

FORWARD BUSY/NO ANSWER

If you have both a Forward on Busy destination and a Forward No Answer destination programmed, you may set both of these at the same time:

- Dial **604**.
- Receive confirmation tone and hang up.

NOTE: If the Hot Keypad feature has been turned off, you must first lift the handset or press the **SPEAKER** button before you begin dialing.

FORWARD FOLLOW ME

When you want all calls to your extension forwarded to the extension where you are now:

- Dial **606** plus your extension number.
- Receive confirmation tone and hang up.

If you want a specific extension's calls forwarded to your phone (Remote Call Forward):

- Dial **606** plus the desired extension number.
- Receive confirmation tone and hang up.

NOTE: If the Hot Keypad feature has been turned off, you must first lift the handset or press the **SPEAKER** button before you begin dialing.

FORWARD DND

To forward your phone when you activate DND.

- Dial **605** plus the extension number or group number.
- Receive confirmation tone and hang up.

NOTE: If the Hot Keypad feature has been turned off you must first lift the handset or press the **SPEAKER** button before you begin dialing.

CALL FORWARD OPTIONS

A display keyset may review or change call forward options and destinations. Call forward access can be done via the keypad or by accessing the keyset display features. To review or change call forward options:

- Press **TRANSFER 102**.
The display will indicate the current call forward condition and destination
OR
Show **0:FORWARD CANCEL** to indicate no forward is set.

- Dial **0** to cancel current condition **OR**
Dial **1-5** to select the forward type **OR**
Press **UP** or **DOWN** to select the forward type.
Press the right soft key to move the cursor.
- Dial the destination number (e.g., **202**) **OR**
Press **UP** or **DOWN** to select the destination
Press the right soft key to move the cursor
- Dial **1** to set **OR**
Press **UP** or **DOWN** to select **YES** or **NO**
- Press **TRANSFER** to store and exit

STATION CALL PICKUP

To pick up (answer) a call ringing at another station, lift the handset and dial **65** plus the extension number of the ringing phone.

If you have a **DP** key assigned with a station number, you only need to press this **DP** key with the flashing light to answer this ringing station.

NOTE: If the Hot Keypad feature has been turned off, you must first lift the handset or press the **SPEAKER** button before you begin dialing.

GROUP CALL PICKUP

To pick up (answer) a call ringing in any pickup group, lift the handset and dial **66** plus the desired group number **01-20** or press the flashing **GROUP PICKUP** button if available.

NOTES:

1. A group pickup button can have an extender for a specific pickup group.
2. If the Hot Keypad feature has been turned off, you must first lift the handset or press the **SPEAKER** button before dialing the access code.

MY GROUP PICKUP

If desired, a new access code can be assigned to pickup ringing calls in the same pickup group as you are in. Like "66" above except you do not need to dial the desired group number. See your installation company for the assigned access code. MY GROUP PICKUP: _____.

PRIVACY RELEASE

This feature will allow another station to join in our conversation by releasing privacy on the C.O. from your phone.

To Release Privacy:

While you are talking on a C.O. line and you wish to have other internal parties (or up to three) join the conversation.

- Press the **PRB** button (the **PRB** button will light steady red). Inform the other party that he/she may now join the conversation.

After the other party (or parties) has joined the conversation and you wish to return privacy to the line so that no one else can join the conversation, press the **PRB** button a second time, the **PRB** button will be off.

To Join a Non-Private Conversation:

When someone has informed you that you can join a conversation:

- Press the **C.O. line** button that he/she has indicated.
OR
- Dial the **C.O. line number** that he/she has indicated.

DIALING FEATURES

SPEED DIALING

You can dial a preprogrammed telephone number stored in the system-wide speed dial list of numbers 500~999 or from your personal list of numbers 00~49.

Your system may be set for 950 system wide numbers. If so the system speed dial access codes are 050~999 and the station speed dial codes are 000~049.

- With the handset on-hook, press the **MEMORY** button or dial **16**.
- Dial the desired speed dial number.
- The telephone number is automatically dialed for you.

NOTE: If the Hot Keypad feature has been turned off, you must first lift the handset or press the **SPEAKER** button before you begin dialing.

PROGRAMMING PERSONAL SPEED DIAL NUMBERS

You can program frequently dialed telephone numbers in a personal speed dial list. A station may be assigned up to fifty numbers, **00-49**. See your system administrator to determine the amount assigned to your station.

- While on-hook, press **TRANSFER** and then dial **105**.
- Dial a speed dial number (**00-49**).
- Dial a line or line group access code.
- Dial the telephone number to be stored (24 digits maximum). It can include #, *, FLASH and PAUSE.
- Press **TRANSFER** to store the number.

NOTE: If the Hot Keypad feature has been turned off, you must first lift the handset or press the **SPEAKER** button before you begin dialing.

For the purposes of programming speed dial numbers, the programmable buttons are known as **A, B, C, D, E** and **F** and are defined on the next page.

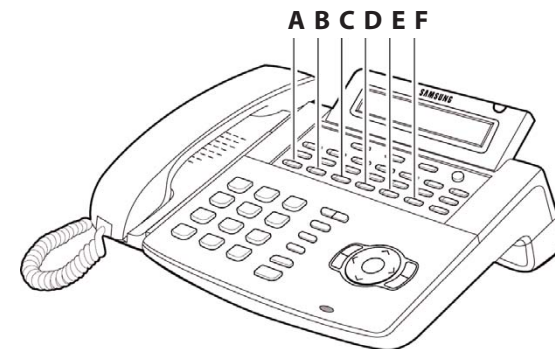

- The **A** button is not used.
- The **B** button inserts a flash.
- The **C** button inserts a pause.
- The **D** button is used for pulse to tone conversion. If your system uses rotary (or pulse) dialing C.O. lines, pressing **D** while entering a speed dial number causes all subsequent digits to be sent as DTMF tones.
- The **E** button is used to hide digits. Display keyset users may want to hide some speed dial numbers so that they will not show in the display. When you are entering a telephone number, press **E**. All subsequent digits will be hidden. Press **E** again to begin displaying digits.
- The **F** button is used to enter a name. [See Personal Speed Dial Names under Display Features.](#)
- Use the **HOLD** button to clear a speed dial number.

ONE TOUCH SPEED DIALING

You may assign any speed dial number to an already existing One Touch Speed Dial button for quick and easy dialing of frequently used numbers.

- While on-hook, press **TRANSFER** and then dial **107**.
- Press a One Touch Speed Dial button.
- Dial the speed dial number (**00–49** or **500–999**) that you want assigned to this button.
- Press **TRANSFER** to store your selection.

To call this telephone number, just press the One Touch Speed Dial button.

NOTE: If the Hot Keypad feature has been turned off, you must first lift the handset or press the **SPEAKER** button before you begin dialing.

LAST NUMBER REDIAL

To redial the last telephone number you dialed, press the **REDIAL** button or dial **19**.

NOTES:

1. If the Hot Keypad feature has been turned off, you must first lift the handset or press the **SPEAKER** button before you begin dialing.
2. Redial does not apply to intercom calls.

MANUAL RETRY WITH REDIAL

While you are on an outside call listening to a busy signal and you want to redial the same number dialed.

- Press the **REDIAL** button.

This will hang up your existing call and manually redial the same number dialed. You can repeat this operation for a limited number of attempts.

NOTE: If your keyset is programmed with Call Log Blocks then the Redial will access the call log when pressed.

SAVE NUMBER WITH REDIAL

To save the number you just dialed for later use, press the **SNR** button before hanging up.

To redial this saved number at any time, press the **SNR** button or dial **17**. The same line will be selected for you.

NOTES:

1. If the Hot Keypad feature has been turned off, you must first lift the handset or press the **SPEAKER** button before you begin dialing.
2. The saved telephone number is stored in memory until you save another number.
3. Redial does not apply to intercom calls.

CHAIN DIALING

You may manually dial additional digits following a speed dial number or chain as many speed dial numbers together as required:

- After the first speed number is dialed, press **MEMORY** again and dial another speed number **OR** manually dial additional digits following a speed dial number.

AUTOMATIC REDIAL/RETRY

When you are making an outside call and you receive a busy signal, the system can automatically redial the number for you. It will automatically redial at a pre-programmed interval for up to 15 attempts.

- When you hear a busy signal, press the **RETRY** button.
- The system will reserve the line and automatically redial the same number for you. You will hear the call being made through the keyset speaker. The microphone is muted.

- When the called party answers, lift the handset or press the flashing **SPEAKER** to begin speaking.

NOTES:

1. If you make another call, auto-redial is canceled.
2. To cancel a retry, lift and replace the handset.

PULSE TO TONE CHANGEOVER

When making an outside call on a dial pulse line, press #. All digits dialed after the # will be sent as tones.

MEMO REDIALING

When you are calling directory information, you can store the number you are given using the **SAVE** feature. There is no need for pencil and paper.

- While you are talking on an outside call, press **SAVE**.
- Dial the telephone number as it is dictated to you on the keypad.
- Press **SAVE** to store the number.

To dial the number, press the **SNR** button. It will select the same line and dial the stored number. If necessary, you can select a different line and then press the **SNR** button.

PAGING AND MESSAGING

MAKING AN INTERNAL PAGE

To make an announcement through the keyset speakers:

- Lift the handset.
- Press the **PAGE** button or dial **55**.
- Dial the desired zone number **0, 1, 2, 3** or **4**.
- After the attention tone, make your announcement.

NOTE: If you have a dedicated page zone button, it is not necessary to press **PAGE** and dial a zone number.

MAKING AN EXTERNAL PAGE

To make an announcement through the external paging speakers:

- Lift the handset.
- Press the **PAGE** button or dial **55**.
- Dial the desired zone number **5, 6, 7** or **8**.
OR
Dial **9** to page all external zones.
- After the attention tone, make your announcement.

NOTE: If you have a dedicated page zone button, it is not necessary to press **PAGE** and dial a zone number.

ALL PAGE

To page all designated keysets and external speakers at the same time:

- Lift the handset.
- Press the **PAGE** button or dial **55**.
- Dial ***** or press the **ALL PAGE** button.
- After the attention tone, make your announcement.

NOTE: The LED on the **PAGE** button will only light when an All Page is in progress.

MEET ME PAGE

- Lift the handset.
- Press the Meet Me Page (**MMPG**) button or dial **54**.
- Dial the desired zone number.
- After the attention tone, instruct the paged person to dial **56**.
- Press **WAIT** or **TRANSFER**.
- Remain off-hook until the person dials **56** from any phone.
- The paged person will be automatically connected with you.

CALL PARK AND PAGE

When you have an outside call for someone who is not at his/her desk, you can park the call prior to paging. The iDCS 500 offers two different methods:

MANUAL PARK ORBITS

- While in conversation, press the **PARK** button.
- Entered a desired orbit number (**0-9**), if the orbit number is busy dial another orbit number. Display users can press ***** to automatically place the call in any available orbit number and see the number in the display.
- Remember the selected orbit number.
- Replace the handset when finished.
- Lift the handset and make a page announcement as previously described (example: "John Smith park two").

To retrieve a parked call from orbit:

- Press the **PARK** button and dial the announced orbit number (**0-9**).
- You will be connected to the parked call.

NOTES:

1. You must have a **PARK** button or park access code to retrieve and place calls in park orbits.
2. If the parked call is not retrieved within a pre-programmed period of time, it will recall your keyset and have a slow flashing amber light. You cannot park and page intercom calls.
3. If the Hot Keypad feature has been turned off, you must first lift the handset or press the **SPEAKER** button before you begin dialing.

AUTOMATIC PARK WITH PAGE BUTTON

- While in conversation, press the **PAGE** button. The call is automatically parked at your station.
- Receive page tone and dial a desired page zone number.
- Make announcement indicating your extension number or the line number. Hang up.

To retrieve an automatically parked call:

- Dial **10** plus the number that was announced. If you have a **PAGPK** button, press it and dial the number that was announced. If you have a **PARK** button, press it and dial the announced orbit number.
- You will be connected to the parked call.

NOTES:

1. If the call is not retrieved within a pre-programmed period of time, it will recall your keyset and have a slow flashing amber light. You cannot park and page intercom calls.
2. If the Hot Keypad feature has been turned off, you must first lift the handset or press the **SPEAKER** button before you begin dialing.

SETTING A MESSAGE INDICATION

When you are calling another station and no one answers or you receive a busy signal, you can leave a message indication:

- Press the **MESSAGE** button or dial **43** and receive confirmation tone.
- Hang up. The **MESSAGE** button on the called station will light. Standard telephones receive special dial tone as a message indication or a lit message lamp, if the phone is equipped with one and they are connected to an 8MWSLI card or a 16MWSLI card on the system.

NOTES:

1. A station can have up to five message indications.
2. If the Hot Keypad feature has been turned off, you must first lift the handset or press the **SPEAKER** button before you begin dialing.

CANCELING MESSAGES

To cancel a message indication that you left at another station, dial **42** plus the extension number of the station at which you left a message.

To cancel all message indications left at your keyset, dial **42** plus your extension. Your **MESSAGE** light will go out.

NOTE: If the Hot Keypad feature has been turned off, you must first lift the handset or press the **SPEAKER** button before you begin dialing.

RETURNING MESSAGES

- Press the **MESSAGE** button or dial **43**. The first station that left a message will be called automatically. If that station does not answer, your **MESSAGE** light will stay on.
- Repeat until all messages have been returned in the order received.
- Your **MESSAGE** light will turn off when all messages have been returned.

NOTES:

1. Display keyset users can view message indications and return them in any order. [See Viewing Message Indications under Display Features.](#)
2. If the Hot Keypad feature has been turned off, you must first lift the handset or press the **SPEAKER** button before you begin dialing.
3. If a message has been left at your keyset by a keyset in Auto Answer, you must manually cancel the message after it has been returned.

PROGRAMMED MESSAGES

When you will be away from your phone for any length of time, you can leave a programmed station message. Display stations calling you will see this message and be informed of your status or follow your instructions.

- Dial **48** plus any of the message codes (**01–20**) listed on the back of this user guide.
- To cancel any of these messages you might have selected, dial **48** plus **00**.
- Press **TRANSFER** to exit and store your selection.

NOTE: If the Hot Keypad feature has been turned off, you must first lift the handset or press the **SPEAKER** button.

You can have multiple programmed message buttons (**PMSG**) and each one can have a different message code:

- Press any programmed message (**PMSG**) button. The message is set and the button will light red. Press the button again to turn off.
- Pressing another programmed message (**PMSG**) button will turn the previous one off and set a different programmed message.

CONVENIENCE FEATURES

DO NOT DISTURB

Use this feature when you want to block calls to your keyset.

- While on-hook, press the **DND** button or dial **401**. The **DND** button lights steady red to remind you of this mode.
- To cancel DND, press the **DND** button again or dial **400**. The **DND** light turns off. You can make calls while in the DND mode.

NOTES:

1. If the Hot Keypad feature has been turned off, you must first lift the handset or press the **SPEAKER** button.
2. If you place your keyset in DND mode and you do not have a **DND** button, your **TSI** button will flash to indicate DND status.

ONE TIME DND

If you are on a call and you do not wish to be interrupted while on that call, you can press the **DND** button and place your station in Do Not Disturb. When you hang up at the end of the call, DND will be automatically canceled and your keyset will be able to receive new calls. This feature requires a **DND** button.

MUTE

You can mute the handset transmitter or the microphone during any conversation:

- Press the **MUTE** button. It will light red.
- To resume speaking, press the **MUTE** button again. The light turns off.

BACKGROUND MUSIC

When a music source is supplied, you may listen to music through the speaker in your keyset:

- While on-hook, press the **HOLD** button to hear music.
- Press the **HOLD** button again to turn music off.

You can set the level of background music by using the **VOLUME** buttons while listening to the music. This does not affect the speakerphone level.

ESTABLISHED CALL PICKUP

To pick up an established call in progress at a single line extension connected to a computer modem on your PC.

- Press the **EP** button for that station on your keyset and the call is automatically moved to your keyset.
- The single line extension on your modem will be disconnected.

NOTE: You must have an assigned (EP button) button on your regular keyset, for the single line station.

APPOINTMENT REMINDER/ALARM CLOCK

This feature works like an alarm clock. Use it to remind yourself of an appointment later in the day (TODAY ONLY) or as a daily reminder every day (DAILY). You can set up to three alarms. Each one can be either a TODAY ONLY or a DAILY alarm.

When the alarm rings, you will hear three short rings repeated three times. Lift the handset to answer the alarm. If you do not, the alarm will alert you two more times at five minute intervals.

To set alarms:

- Press **TRANSFER** and then dial **112**.
- Dial the alarm number **1, 2** or **3**.
- Dial the time at which you want the alarm to sound. Enter the time as HHMM (hours and minutes) using the 24 hour clock.
- Dial **0** (NOT SET), **1** (TODAY ONLY) or **2** (DAILY) to select the alarm type.
- Press **TRANSFER** to save.
- Repeat for each alarm if needed.

To cancel individual alarms:

- Press **TRANSFER** and then dial **112**.
- Dial alarm number **1, 2** or **3**.
- Press the **HOLD** button.

NOTE: Display keysets can show a reminder message. [See Alarm Reminder Messages under Display Features.](#)

ANSWERING THE DOOR PHONE

When you are programmed to receive calls from a door phone:

- You will receive three short rings repeated.
- Lift the handset or press **SEND** button. You are connected to the door phone.
- If an electric door lock release is installed, dial **13** to unlock the door.

CALLING THE DOOR PHONE/ ROOM MONITOR

You may call the door phone and listen to what may be happening outside or in another room.

- Dial the extension number of the door phone.
- You will be connected to the door phone and you can listen or have a conversation.
- If an electric door lock release is installed, dial **13** to unlock the door.

NOTE: If the Hot Keypad feature has been turned off, you must first lift the handset or press the **SPEAKER** button.

EXECUTIVE/SECRETARY HOT LINE

If programmed, an executive and a secretary can have a hot line between them. When the executive station is in the DND mode, all of its calls will ring the secretary station.

- Either person can press the **BOSS** button to make a voice call to the other station.
- Using the hot line will override DND at the other station. This button will light red when the other station is in use.

To transfer a call to a Boss in DND:

- Press the **TRANSFER** button followed by the **BOSS** button.
- Wait for the **BOSS** to answer to announce the call and hang up to complete the transfer **OR**
- Hang up to complete a blind transfer after pressing the **BOSS** button.

GROUP LISTENING

When you are engaged on a call and you are using the handset, you may want other people to hear the distant party's voice over the speaker:

- Press the **LISTEN** button to turn on the speaker. The microphone is not in use, so the distant party does not hear other parties present in your office.
- Press **LISTEN** again to turn the speaker off and resume private conversation.
- Repeat if necessary.

NOTE: Depending on speaker volume and the acoustics of your office, it may be advisable to turn the group listening feature off before hanging up. This will eliminate a momentary squeal.

ACCOUNT CODES

When equipped with optional equipment, your system will allow calls to be charged to a specific account.

- During any outside C.O. call, press the account (**ACC**) button.
- Enter the 3 digit account code bin number when prompted, **OR** If your button has an extender of 000 enter the account code (maximum 12 characters including Q and #) and press **ACC000** again, **OR** If your button has an extender other than 000 (001~999) account code contained in that bin will automatically be entered for you.

LOCKING YOUR KEYSSET

You can lock your keyset to control misuse of your phone while you are away. You can unlock it when you return. Your default station passcode is 1234.

- While on-hook, press **TRANSFER** and then dial **100**.
- Dial your four digit station passcode.
- Dial **1** to locking outgoing, **2** for locked all calls, or **0** to unlock.
- Press **TRANSFER** to store your selection.

	0 UNLOCKED	1 LOCKED OUTGOING	2 LOCKED ALL CALLS
Make outside calls	YES	NO ACCESS DENIED	NO
Receive outside calls	YES	YES	NO
Make intercom calls	YES	YES	NO
Receive intercom calls	YES	YES	NO

MANUAL SIGNALLING

Use this feature when you want to send a brief 500ms ring burst to another station, regardless of the status of your phone (on-hook, off-hook, handsfree, DND, or ringing).

To send a signal to another station:

- Press the Manual Signalling (**MS**) button.
- You may press the **MS** button repeatedly to send multiple signals to the designated station.

NOTE: Your phone must have a Manual Signalling (MS) button with a station number extender assigned to it.

OFF-HOOK VOICE ANNOUNCE

Keysets may receive a voice announcement while on another call. The calling station must have an **OHVA** button. When you are in DND, you cannot receive OHVA calls. The OHVA feature will work with intercom and transferred calls.

When you receive an OHVA and secure OHVA is ON, you will hear the announcement in the handset receiver, if you are using the handset. If secure OHVA is OFF then you will hear the announcement on the speaker, if you are talking on the handset. If you are using the speakerphone the announcement will always be heard through the speaker.

To make an off-hook voice announcement:

- Dial the extension number or press the **DSS** button.
- When you receive a busy signal, press the **OHVA** button.
- After the attention tone, begin speaking.
- Finish the call by replacing the handset or pressing the **ANS/RLS** button.
- Press the flashing **CALL** button on your keyset. This will place the original party on hold and allow you to talk to the announcing party.
- To return to your first party, press the button corresponding to your original call. This will disconnect the OHVA call.

NOTES:

1. When you are voice announcing to a station close to you, use the handset to avoid an echo effect.
2. You cannot off-hook voice announce to single line telephones.

OHVA BLOCK

Your keyset can be programmed with an OHVA Block (**BLOCK**) button. Pressing this button will prevent anyone from making an OHVA to you until you press the button again and cancel the blocking.

OHVA REJECT

Your keyset can be programmed with an OHVA Reject (**REJECT**) button. Pressing this button while receiving an OHVA call will disconnect the voice announcing party and return you to your original call.

IN GROUP/OUT OF GROUP

If your keyset is assigned to a station ring group, you can remove your keyset from the group and then put it back in. While you are out of the group, you can receive calls to your extension number but not calls to the group number. If you have an **IN/OUT** button with the group number assigned.

- Press the **IN/OUT** button. It will light red when your keyset is in the group.
- Press the **IN/OUT** button again to exit the group and turn the light off. Repeat as necessary.

If you do not have an **IN/OUT** button:

- Dial the **IN/OUT** access code number _____, then the group number, then **0** to exit the group or **1** to enter the group.

NOTE: If the Hot Keypad feature has been turned off, you must first lift the handset or press **SPEAKER** button.

The **IN/OUT** button can include an extender to indicate the specific group that this button will affect. This means that if you are in multiple groups, you can decide for which groups you will receive calls.

CUSTOMIZING YOUR KEYSSET

AME PASSWORD

This feature allows people using the AME feature to enable password protection. This will prevent unauthorized people from listening to your messages being left. The passcode is the same as your station passcode. This feature only applies if there is an SVM card installed in the system and your keyset has a programmed AME button.

- With the handset on-hook, press **TRANSFER** and then dial **110**.
- Dial **101** to turn on AME PASSCODE or **100** to turn it off.
- Press **TRANSFER** to store your selection.

AUTO CAMP-ON

This option allows intercom calls to be automatically camped on, if possible, when a busy station is called.

- With the handset on-hook, press **TRANSFER** and then dial **110**.
- Press **081** to turn CAMP-ON on or **080** to turn it off.
- Press **TRANSFER** to store your selection.

SELECT RING TONE

Each keyset user can select any one of eight ring frequencies:

- While on-hook, press **TRANSFER** and then dial **111**.
- Dial **1-8** or press the **UP** and **DOWN** buttons to hear each tone.
- When you hear the tone that you prefer, press **TRANSFER** to save it.

NOTE: Specific lines or stations may be programmed to ring with a different tone than what you have selected for your keyset.

CHANGE YOUR PASSCODE

From the factory, your station passcode is 1234. You can change your station passcode whenever you desire.

- While on-hook, press **TRANSFER** and then dial **101**.
- Dial your old passcode.
- Dial a new passcode (must be four characters). You can use **0-9**.
- Redial the new passcode to verify. If successful, you will hear two beeps. Four beeps indicate an incorrect code. Reenter the code again.
- Press **TRANSFER** to store the new passcode.

SET ANSWER MODE (INTERCOM)

You can receive internal calls in one of three modes ([see Answering Intercom Calls under Intercom Calls for descriptions](#)):

- While on-hook, press **TRANSFER** and then dial **103**.
- Dial **0** for Ringing, **1** for Auto Answer or **2** for Voice Announce.
- Press **TRANSFER** to store your selection.

NOTE: When your keyset is programmed for Auto Answer and you have Forward No Answer (FNA) turned on, you must answer screened transfers by pressing the **ANS/RLS** button before your FNA timer expires or the call will forward.

SET ANSWER MODE (CO)

Your incoming CO calls can be set to follow the intercom answer mode.

- While on-hook, press **TRANSFER** and then dial **110**
- Dial **15** to access **AUTO ANS CO**.
- Press the **VOLUME UP** or **DOWN** key to change status.
- Press **TRANSFER** to store your selection.

NOTE: When your keyset is programmed for Auto Answer and you have Forward No Answer (FNA) turned on, you must answer screened transfers by pressing the **ANS/RLS** button before your FNA timer expires or the call will forward.

AUTOMATIC HOLD

While on an outside call, pressing a line button, route button or a flashing **CALL** button will automatically put your call on hold and connect you to the next call. This feature can be turned on or off at your keyset.

- With the handset on-hook, press **TRANSFER** and then dial **110**.
- Dial **001** to turn Automatic Hold on or **000** to turn it off.
- Press **TRANSFER** to store your selection.

NOTE: Intercom calls can be automatically put on hold by pressing **TRANSFER**.

HEADSET OPERATION

Keyset users can switch between headset mode and handset mode. When using headset mode, press the **SEND/END** or **ANS/RLS** button to answer and release calls.

- With the handset on-hook, press **TRANSFER** and then dial **110**.
- Dial **021** to use the headset or **020** to use the handset.
- Press **TRANSFER** to store your selection.

Your keyset may be equipped with a Headset mode button. If it is so equipped pressing this button while the light is out will cause the keyset to enter headset mode and the light will illuminate to indicate this. Pressing the button while the light is lit will cause the keyset to return to handset mode and the light will go out.

HOT KEYPAD

On your phone system your keyset's keypad can be made "live" or "hot" so that it is not necessary to lift the handset or press the **SPEAKER** button before you begin dialing. Calls can be made and features activated by simply dialing the C.O. line number, trunk group access code, intercom number or feature access code. To activate this feature:

- With the handset on-hook, press **TRANSFER** and then dial **110**.
- Dial **031** to turn the Hot Keypad on or **030** to turn it off.
- Press **TRANSFER** to store your selection.

KEY CONFIRMATION TONE

You can hear a short beep (confirmation tone) each time you press a button on the dial pad. This tone can be turned on or off.

- While on-hook, press **TRANSFER** and then dial **110**.
- Dial **040** to turn tones off or **041** to turn tones on.
- Press **TRANSFER** to store your selection.

REJOINING A PAGE

This feature allows you to hear the remaining portion of an ongoing internal page after you return your keyset to idle. To enable this feature:

- With the handset on-hook, press **TRANSFER** and then dial **110**.
- Dial **051** to turn this feature on or **050** to turn it off.
- Press **TRANSFER** to store your selection.

RING PREFERENCE

This feature automatically answers ringing calls when you lift the handset or press the **SEND** or **ANS/RLS** button. This method will always answer calls in the order they arrived at your keyset. When you turn ring preference off, you must press the flashing button to answer a call, allowing you to answer calls in the order you choose.

- With the handset on-hook, press **TRANSFER** and then dial **110**.
- Dial **061** to turn ring preference on or **060** to turn it off.
- Press **TRANSFER** to store your selection.

AUTO ANSWER CO CALLS

This option will allow CO calls that directly ring your phone to auto answer. When a CO call arrives at your station and this option set for ON your phone will sound two beeps, the same as when a screened transfer is completed, and you will be connected to the CO call. In order for this option to work the station must also be programmed for auto answer ([see SET ANSWER MODE](#)).

- While on hook, press **TRANSFER** and then dial **110**.
- Dial **151** to turn Auto Answer CO on or **150** to turn it off.
- Press **TRANSFER** to store your selection.

NOTE: Outside lines must ring your station directly for the Auto Answer CO to work. Lines ringing a station group will not cause your phone to Auto Answer.

DISPLAY SPEED DIAL NAME

This option allows you to view the name associated with a speed dial number as it is dialed.

- With you handset on-hook, press **TRANSFER** and then dial **110**.
- Press **111** to turn **DISP SPDNAME** on or **110** to turn it off.
- Press **TRANSFER** to store your selection.

CALLER ID REVIEW ALL

This feature allows display keyset users to review Caller ID information for calls sent to their stations. This list can be from ten to fifty calls in a first in, first out basis. The list includes calls that you answered and calls that rang your station but that you did not answer. When reviewing this list, you can press one button to dial the person back. The system must be using LCR to dial the stored number.

- With you handset on-hook, press **TRANSFER** and then dial **110**.
- Press **121** to turn **CID REVIEW ALL** on or **120** to turn it off.
- Press **TRANSFER** to store your selection.

SECURE OHVA

This option allows you to receive OHVA calls via the speaker while you are on the handset.

- With you handset on-hook, press **TRANSFER** and then dial **110**.
- Press **131** to turn **AUTO CAMP-ON** on or **130** to turn it off.
- Press **TRANSFER** to store your selection.

ENBLOCK DIALING

This option allows you to dial digits then press the **SEND** button to make the call (like a cellphone).

- While the handset on-hook press **TRANSFER** then dial 110.
- Dial **161** to turn Enblock Dialing ON or **160** to turn it off.
- Press **TRANSFER** to store your selection.

DISPLAY FEATURES

INTERACTIVE DISPLAY KEYS

The three keys below the display are substitutes for dedicated feature keys and access codes. Pressing one of these buttons has the same effect as pressing a programmable button. These buttons are called soft keys as their functions are not fixed. They change to present you with the best options for that call condition. The use of soft keys allows the programmable buttons to be used for more **DSS** and speed dial buttons.

The **SCROLL** button is used to display options available to the user at a particular time or during a specific procedure. Press this button once while in the idle state to view the three main categories available.

201: STN NAME
CALL OTHER ANS

ANSWER: Guides you through the options to answer calls.

OTHER: Guides you through features other than making or answering calls.

CALL: Guides you through the options to make a call.

Select one of the main categories: **CALL**, **OTHER** or **ANS** (**ANSWER**). Press the **SCROLL** button to display additional options available under each of the three main categories. The symbol ➡ displayed as the last character on the lower line of the display indicates that there are additional options. Press the **SCROLL** button to display these additional options.

User instructions will be displayed in lower case letters. Options assigned to soft keys will be in upper case letters.

DIRECTORY INFORMATION

An 11 character directory name can be assigned to each extension number. Display keyset users can view the name of the called or calling station before answering.

Each outside line can have an 11 character directory name. Incoming calls can be easily identified and answered with different greetings.

Outside and internal calls ringing to a station group will display [CALL FOR xxx] where xxx is the station group number. This allows you to answer calls directed to you differently than calls directed to your group.

CALL LOG *(See also Special Application Menu-Outgoing Call Log)*

The system can log both incoming and outgoing calls placed from or to your telephone. You must have a **LOG** button programmed on your keyset and assigned a review list.

Each **IN** and **OUT** list can be up to 50 numbers maximum. They are assigned in blocks of 10 each.

- Press the **LOG** key.
- Press either the **IN** or **OUT** key.
- View the first IN/OUT telephone number. At this point you may select one of the three options related to this number or use the UP/DOWN keys to scroll through your list of calls.
- Press the **CLEAR** button to erase this number from the list.
- Press the **NND** key repeatedly to view the Name, Number, or Date associated with this call.
- Press the **DIAL** key to call this number.

These options are the same for the incoming or outgoing call logs.

DIAL BY NAME *(See also Special Application Menu-Name Search)*

Each station or speed dial number can have an associated directory name. A station or speed dial number can be selected by scrolling alphabetically through a directory name list. This on-line "phone book" allows the user to look up and dial any station or speed dial number in seconds.

- Press the **DIR** button (**DIRECTORY**).
- Select the directory you wish to use: **PERS** (personal speed dial numbers), **SYS** (system speed dial numbers) or **STN** (station names).
- Dial the key on the keypad that corresponds to the first letter of the name you wish to search for.
- Use the **UP** and **DOWN** arrows to scroll through the names.
- Press the **DIAL** soft key to dial the number.

NOTE: A **DIR** button can have an extender to take you directly to one of the above lists (**PERS**, **SYS**, or **STN**).

CALL PROGRESS DISPLAYS

During everyday call handling, your keyset display will provide information that is helpful and in some cases invaluable. Displays like [CALL FROM 203], [TRANSFER TO 202], [701: RINGING], [TRANSFER FM 203], [708 busy], [Camp on to 204], [Recall from 204], [Call for 501], [message frm 204] and [FWD ALL to 204] keep you informed of what is happening and where you are. In some conditions you are prompted to take an action and in other cases you receive directory information.

DISPLAY NUMBER DIALED

Display keysets begin showing digits as they are dialed. They will stay in the display until the call duration timer comes on automatically or the **TIMER** button is pressed. If the call duration timer is not used, the number dialed will be displayed until the call is released, transferred or put on hold.

CALL DURATION TIMER

The system can be set to automatically time outside calls. A few seconds after you dial a telephone number, the timer appears in the display. It appears immediately for incoming calls. The call timer continues for the duration of the call. Call duration times are displayed in minutes and seconds. If a call lasts longer than 60 minutes, the timer restarts.

You can press the **TIMER** button to manually begin timing a call. Press it again to stop timing. If you press it while the automatic timer is on, the call duration time is restarted.

AUTO TIMER

Display keyset users may have the timer automatically start when they answer incoming calls or after a short delay on an outgoing call.

- With the handset on-hook, press **TRANSFER** and then dial **110**.
- Dial **011** to turn the auto timer on or **010** to turn it off.
- Press **TRANSFER** to store your selection.

TIMER FUNCTION

Display keyset users may use this feature as a simple stopwatch.

- When the keyset is idle, press the **TIMER** button to start timing.
- Press the **TIMER** button again to stop timing.
- Read the elapsed time in the display.
- Lift the handset and replace it. The display will return to date and time.

VIEWING MESSAGE INDICATIONS

You can view all of your message indications before you return them:

- With the handset on-hook, press the **MESSAGE** button with the red flashing light.
- The first station that left a message indication will be displayed.
- Press the **UP** and **DOWN** arrows to scroll through the stations that left message indications. Use the soft keys to reply, clear or advance to the next message.
- Press the **END** or **ANS/RLS** button to return your keyset to the idle condition.

ALARM REMINDER MESSAGES

(See also Special Application Menu-Name Search)

When you use the alarm/appointment reminder feature, you create a 16 character reminder message. When the alarm rings, your message will appear instead of [ALARM REMINDER]. To program reminder messages:

- Press **TRANSFER** and then dial **116**.
- Dial the alarm number **1, 2** or **3**.
- Dial the time you want the alarm to go off. Enter the time as HHMM (hours and minutes) using the 24 hour clock.
- Dial **0** (NOT SET), **1** (TODAY) or **2** (DAILY) to select the alarm type.
- Write your message using the dial pad keys. Each press of a key selects a character. Pressing the next key moves the cursor to the next position. For example, if your message is "TAKE MEDICATION," press **8** once to get the letter "T." Press **2** once to get "A." Press **5** twice to get "K." Continue selecting characters from the following table to complete your message.
- Press the **TRANSFER** button to store the alarm and reminder message.
- Repeat for each alarm if needed.

COUNT	1	2	3	4	5
DIAL 0	<	>	.)	0
DIAL 1	space	?	,	!	1
DIAL 2	A	B	C	@	2
DIAL 3	D	E	F	#	3
DIAL 4	G	H	I	\$	4
DIAL 5	J	K	L	%	5
DIAL 6	M	N	O	^	6

DIAL 7	P	Q	R	S	7
DIAL 8	T	U	V	Q	8
DIAL 9	W	X	Y	Z	9
DIAL *	:	=	[]	*

NOTES:

1. When the character you want appears on the same dial pad key as the previous character, press **UP** to move the cursor one space to the right.
2. Other symbols are available for DIAL #.

To cancel an individual alarm and reminder message:

- Press **TRANSFER** and then dial **112**.
- Dial alarm number **1, 2** or **3**.
- Press the **HOLD** button.
- Press the **TRANSFER** button.

PERSONAL SPEED DIAL NAMES

Each personal speed dial number can have an 11 character name assigned to it. This name is used to select the speed dial bin when you are dialing by directory.

- Press **TRANSFER** and then dial **106**.
- Dial the speed dial bin number **00-49**.
- Write your message using the procedure described in *Alarm Reminder Messages*.
- Press the **TRANSFER** button to store the speed dial name.
- Repeat for each speed dial bin if necessary.

STATION NAMES

You can assign an 11 character name to your keyset. This allows other display keyset users to call you using the directory dial feature.

To program a station name:

- Press **TRANSFER** and then dial **104**.
- Enter the 11 character name using the procedure described in *Alarm Reminder Messages*.
- Press **TRANSFER** to store the name.

MANAGING KEY ASSIGNMENTS

You can view your key assignments and add extenders to some of your programmable keys for easy one touch operation of frequently used features.

- While on-hook, press **TRANSFER** and then dial **107**.
- Use the **VOLUME** buttons to scroll through all of your programmable buttons **OR** press the programmable button to which you want to add the extender.
- When you reach a key listed below, dial the corresponding extender.
- Press **TRANSFER** to store and exit programming.

Please refer to the [Enhanced Display Programming Section](#) provided by your installation company when requested for a complete list of descriptions and extenders for any keys you may have programmed on your keyset.

NOTE: Confirm that the cursor is placed correctly before you enter the extender.

LCR WITH CLEAR

When you are making an outside call using LCR and dial an incorrect digit, you can press the **CLEAR** soft key to reenter the telephone number. You do not need to redial **9** to reaccess LCR.

BACKSPACE WITH LCR

If you misdial while using LCR, you can delete digits shown in the display by pressing the **BSPC** soft key as many times as necessary.

TEXT MESSAGING

This feature allows two digital keyset users to respond to each other with pre-programmed text messages. After receiving an Off Hook Voice Announcement or Station Camp-On, you may respond with a text message while continuing to talk and listen to your outside party. The other station can view this message and take the appropriate action or respond back with another text message.

You **must** be permitted to use the Text Messaging feature. See your System Administrator or Technician to be assigned this feature. They will assign you ten (10) blank messages. You can create any 16 character messages (01 to 10) that are appropriate for your use.

NOTE: See [ALARM REMINDER MESSAGES](#) for instructions on how to enter characters to create a text message.

Familiarization with the two digit message numbers you will use the most will make this procedure quick and easy. However if you do not know them, use the **UP/DOWN** button to scroll to the desired message, then press **SEND**.

The basics steps in text messaging are:

1. Press **TMSG** soft key to begin text messaging.
2. Dial the 2 digit number for the desired message.
3. Confirm this is the intended message then press **SEND**.
4. Wait for a reply from the other station (steps 1, 2 & 3)
5. When any station presses **EXIT** the displays at both stations return to their previous call progress condition.

At all times after step 1 you can talk and listen to your caller while repeating steps 2.

The following example will better demonstrate how to use Text Messaging. In this example station 201 is making an off hook voice announcement to station 205 who after hearing the announcement will respond with a text message.

STATION 201: LINDA
received a call on line 702

STATION 205: JOHN
is talking on line 701

Talking on line 702



Press **TRANSFER**

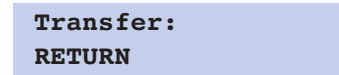

Dial **205**

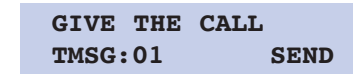
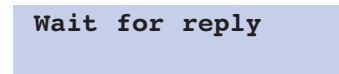
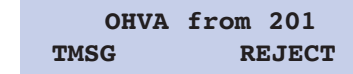
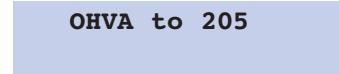

Dial **03** or press **↑** twice

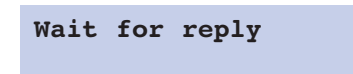
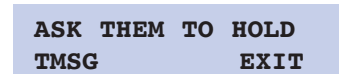

CALLER ID

WHAT IS CALLER ID?

Caller ID is the name given to the telephone company-provided feature that delivers the telephone number and sometimes the name of the person calling your phone. There are two types of Caller ID; the first delivers the calling party's telephone number only and the second (sometimes referred to as "Deluxe" Caller ID) delivers both the calling party's telephone number and name as listed in the telephone directory.

The phone system can handle both types of Caller ID; in fact, in the case of number only delivery, the system can be programmed to insert a name for a specific telephone number. However, even though you are paying to receive Caller ID information, there are some circumstances that mean you will not receive this information. The six most common reasons are listed below along with the display information that the system will provide.

PRIVATE	The caller does not wish his/her name or number to be revealed to you. This type of call can be stopped at the telephone company by dialing an access code on your outside lines. This will redirect these PRIVATE calls to an announcement that states that you do not wish to receive calls that have had Caller ID blocked. The code to block these calls can usually be found in the front section of the telephone directory.
OUT OF AREA	The caller is calling from an area that cannot provide Caller ID information (for example, international calls) or he/she is calling from a type of circuit that cannot provide Caller ID information, for example, some outbound WATS lines.
PAYPHONE	The caller is calling from a coin-operated telephone. The telephone company will send this information as there are no directory listings for pay phones. The number will be delivered as usual.
INVALID CID INFO	This is a message that will be displayed when CID information is sent on the line but was somehow corrupted.
NO CID RECEIVED	This is a message that will be displayed when there was no CID information sent on the line.

NO CID DSP

Caller ID Digital Signal Processors (CIDDSP's) are resources in the iDCS system required for receiving CID data. If there are no CIDDSP's available at the time a call comes in, this is the message you will see on your display.

NOTE: The Caller ID features require optional software and/or hardware. Please see your service and installation company for details.

WHAT IS ANI?

ANI (Automatic Number Identification) is a feature offered by some telephone service providers that provides the calling party's telephone number. This service is only available on E&M Tie Lines on a T1, digital trunk. ANI is similar to Caller Identification (CID) but the format and information of the calling person is different. CID uses FSK signalling and ANI uses DTMF signalling. Usually, with ANI, a calling party's identity is the Listed Directory Number (LDN) unless a separate bill-to-number has been specified, (in which case the bill-to-number will be sent). Note that ANI does not provide calling party NAME, only the number. The phone system can provide calling number to name translation table.

WHAT IS CLI?

On ISDN circuits, calling party information is called CLI and is supported on both BRI and PRI type circuits on the iDCS. On BRI circuits the iDCS only supports number delivery and, like ANI, a name can be attached to the telephone number of frequent callers via the Caller ID translation table. On 5ESS and NI2 PRI circuits both name and number support is provided on the iDCS system. On a DMS100 circuit only number service is provided.

SELECTING YOUR CALLER ID DISPLAY

You can decide if you want to see the Caller ID name or Caller ID number in the display. Regardless of which one is selected, you can press the **NND** button to view the other pieces of Caller ID information. To select the type of Caller ID information you wish to view first:

- With the handset on-hook, press **TRANSFER** and then dial **119**.
- Dial **0** for CID options, **1** for ANI options, or **2** for CLI options.
- Dial **0** if you do not wish to view CID information, **1** to view the NUMBER first or **2** to view the NAME first.
- Press **TRANSFER** to exit and store your selection.

VIEWING THE NEXT CALLER ID CALL

In the event that you have a call waiting or a camped-on call at your keyset, you can press the **NEXT** button to display the Caller ID information associated with the call in queue at your keyset. Either the CID name or CID number will show in the display depending on your Name/Number selection.

To view Caller ID information for calls that have been camped-on to your keyset, press the **NEXT** button. If your keyset does not have a **NEXT** button, press the **CID** button and then the **NEXT** soft key.

SAVING THE CALLER ID NUMBER

At any time during an incoming call that provides CID information, you may press the **SAVE** button to save the CID number. If your keyset does not have a **SAVE** button, press the **CID** button, the **SCROLL** button and then the **SAVE** soft key. The system must be using LCR to dial the saved number.

REDIALING A SAVED CALLER ID NUMBER

To redial a number that has been saved, press the **SNR** button or dial **17**.

NOTES:

1. Your telephone system must have LCR correctly programmed to redial the saved number.
2. If the Hot Keypad feature has been turned off, you must first lift the handset or press the **SPEAKER** button before you begin dialing.

STORING A CALLER ID NUMBER

At any time during an incoming call that provides CID information, you may save the CID number as a speed dial number in your personal speed dial list. To store a Caller ID number in a personal speed dial bin:

- Press the **STORE** button. The system displays the speed dial bin in which the number was stored, **OR**
- Press the **CID** button and then press the **SCROLL** button.
- Press the **STORE** soft key.
- The system displays the speed dial bin in which the number was stored.

NOTE: Your telephone system must have LCR correctly programmed to redial the saved number. If LCR is not being used on your system, you will not be allowed to STORE CID numbers.

INQUIRE CALLER ID PARK/HOLD INFO

If you are informed that an incoming call is on hold or has been parked for you, you may view the Caller ID information before you retrieve the call. This may influence how you choose to handle the call.

From an idle keyset:

- Press the **INQUIRE** button, **OR**
Press the **CID** button and then the **INQUIRE** soft key.
- Dial the trunk number.
- You may now answer the call by pressing the **ANS** button, **OR**
You may use **NND** to view more information about this call, **OR**
You can return to the idle condition by pressing **IGNORE**.

If you are on a call:

- Press the **INQUIRE** button. Your existing call will go on hold, **OR**
Press the **CID** button and then the **INQUIRE** soft key to place the first call on hold.
- Dial the trunk number.
- You may now answer the call by pressing the **ANS** button, **OR**
You may use **NND** to view more information about this call, **OR**
You can return to the idle condition by pressing **IGNORE**.

NOTES:

1. If you are on an intercom call or you have Automatic Hold turned off, you must finish the existing call or place it on hold before inquiring.
2. If you inquire about an outgoing call, you will receive a [call no longer available] display.

REVIEWING PAST CALLER ID CALLS

This feature allows you to review CID information for calls sent to your keyset. This list can contain 10–50 calls in a last-in, first-out basis. The list includes calls that you answered and calls that rang your keyset but that you did not answer. When reviewing this list, you can press one button to dial the person back. The system must be using LCR to dial the stored number. To access the CID information stored in your REVIEW list:

- Press the **REVIEW** button, **OR**
Press the **CID** button and then press the **REVIEW** button.

- If you have entries in your review list, the most recent call will be shown first.
- You can now **CLEAR** this entry, **OR** Use **NND** to view more information about this call, **OR** Press **DIAL** to call this person back, **OR** Press **SCROLL** and then press **STORE** to save this number in a personal speed dial bin.

NOTES:

1. Each keyset defaults with ten review bins. Please see your system administrator to determine the number of bins assigned to your keyset.
2. Your system must have LCR correctly programmed to allow you to **DIAL** numbers from the review list or to **STORE** entries from the review list.

SPECIAL APPLICATION MENU

Below are instructions for additional call processing and special applications that can be accomplished via the LCD programming. These features and functions can be accessed by pressing the **MENU** button. Follow the user instructions below to utilize these features and functions.

After pressing the **MENU** button, use the direction button to scroll to the desired menu option. Press **ENTER** to access the menu. To navigate within the menu you may scroll to the desired option/function or dial the associated option function number.

Press **END** button to exit programming.

MENU OPTIONS

Note that some of the features listed here may require system programming and configuration in order to function. See your system administrator for details.

Press the **MENU** button to access the options below. Use the **UP/DOWN** directional button to scroll to, and within option menus and sub menus. You may also dial the option number, after pressing the **MENU** button.

1. **OUTGOING LOGS:** Allows you to view a list of the 30 most recent outgoing calls from the keyset. You may return the call directly from the displayed status.
 - Scroll or dial option number **1. Outgoing Call Log.**
 - Press **ENTER.**
 - Scroll to the desired **PHONE NUMBER** and press the **SEND** button to automatically dial the number.

OR

 - Press **CANCEL** to return to Main Menu.

OR

 - Press **END** to exit programming.
2. **INCOMING LOGS:** Allows you to view a list of the 30 most recent incoming calls to the keyset. You may return the call directly from the displayed status.
 - Scroll or dial option number **2. Incoming Call Log.**
 - Scroll to the desired **PHONE NUMBER** and press the **SEND** button to automatically dial the number.

OR

 - Press **CANCEL** to return to Main Menu.

OR

- Press **END** to exit programming.

3. SPEED DIAL: Allows you to search through Station and System Speed Dial Numbers. You may dial the number directly from the displayed status.

- Scroll or dial option number **3. Speed Dial**.
- Press **ENTER**.
- Scroll to option or dial desired option.

1. Personal Speed
2. System Speed

- Press **ENTER**.

OR

- Scroll to the desired number and press the **SEND** button to automatically dial the number.

OR

- Press **CANCEL** to return to main menu.

OR

- Press **END** to exit programming.

4. DIRECTORY DIAL: Allows you to search for station speed, system speed and station numbers based on their associated programmed name.

- Scroll or dial option number **4. Directory Dial**.
- Press **ENTER**.
- Scroll to option or dial desired option.

1. Personal Speed
2. System Speed
3. Station Number

- Enter the name associated with that speed number or station number.
- Press the **SEND** button to automatically dial the number.

OR

- Press **CANCEL** to return to main menu.

OR

- Press **END** to exit programming.

5. FORWARD SET: Allows you to assign station call forward condition for the phone. You must first set the forward type and destination (Options 2-5) then activate the forwarding in option 1.

- Scroll or dial option number **5. Forward Set**.
- Press **ENTER**.
- Scroll to or dial the desired forward option and assign station number to forward your station to.

2. ALL FWD NO.
3. BUSY FWD NO.
4. NOANS FWD NO.
5. DND FWD NO.
0. FWD CANCEL

- Press **ENTER**.
- Scroll to or dial **1. FORWARD TYPE** and scroll to or dial the desired forward type.
- Press **ENTER** to activate the desired call forward type.
- Press **CANCEL** to return to main menu.

OR

- Press **END** to exit programming.

6. ALARM REMINDER: Allows you to set an Alarm Reminder. Up to three alarms may be set.

- Scroll or dial option number **6. Alarm Reminder**.
- Scroll or dial the desired Alarm number (Alarm 1-3).
- Press **ENTER**.
- Enter Alarm Type.
 0. NOT SET: Disables alarm.
 1. TODAY: Rings alarm one time only, on the day set.
 2. DAILY: Rings alarm daily at time set.
- Press **ENTER**.
- Display confirms setting and returns to that alarm set menu.
- Scroll up to set **ALARM TIME**.
- Press **ENTER**.
- Enter **ALARM TIME** (Military Format).
- Press **ENTER**.
- Display confirms setting.
- Press **CANCEL** to return to main menu.

OR

- Press **END** to exit programming.

SVMi-8/SVMi-16E

This section describes how to setup and use the various features available to a Subscriber. A Subscriber is a person that has been authorized access to the various features and services available in the SVMi-8/SVMi-16E. Please review this section carefully before you use your Authorized Features and Services, known as Subscriber Services.

Voice Mail is one of the Subscriber Services available. Your voice mail box has the capability of storing private messages, and offers a number of options for sending or redirecting messages as well as provides several ways to notify you of new messages.

Another very common Subscriber Service is Access Manager. This allows you control over when and where you receive your calls as well as what to speak to your callers in the event you are unable to speak to them directly. The 'events' are referred to as "Call Conditions". No-Answer, Busy, and Blocked are the most commonly used Call Conditions.

This guide can be used by Subscribers from within the office or from telephones outside the office. The basic operation is the same, but the access method will be different. [See the SVMi-8/SVMi-16E Subscriber Services Menu Diagram for more details.](#)

Note that some features and prompts detailed here may not be available to all Subscribers. See your System Administrator if you have questions about feature availability.

ACCESSING YOUR MAILBOX

[Also known as Subscriber Services Menu]

Inside Callers *[Subscriber logging in from their Desk]*

- Dial the SVMi-8/SVMi-16E access number or press the key assigned to ring SVMi-8/SVMi-16E **[VMMMSG]**.
- Enter your personal password when prompted (the default password is 0000).

Outside Callers *[Subscribers calling from Cell Phones or outside of the office environment]*

- Dial the phone number that will be answered by the SVMi-8/SVMi-16E. The main greeting will answer.
- At the main greeting dial **[#]** plus your Subscriber (or mailbox) number (Subscriber and Mailbox numbers will usually match your extension number).
- Enter your personal password when prompted (the default password is 0000).

Access your Subscriber Services (or Mailbox) from a Station other than your Own (or checking a mailbox associated with a different station)

- Press the **[VMMMSG]** key or dial the SVMi-8/SVMi-16E **group number**. You will be prompted to enter a password.
- Press **[*]**. This will take you to the Main Auto Attendant Menu.
- Press **[#]** plus the Subscriber number of your choice. You will be prompted to enter your password.

At this point the inside and outside callers follow the same instructions. You will hear a message stating the number of messages left in your mailbox. You will then hear the Subscriber Services Menu with the following options:

- 1 Listen to New Messages - [See Listening to your Message.](#)**
 - 2 Record and Send Message - [See Sending Messages.](#)**
 - 3 Review Saved Messages - [See Listening to your Message.](#)**
 - 4 Access Manager - [See Access Manager.](#)**
 - 5 Personal Greetings - [See Personal Greetings.](#)**
 - 6 Mailbox Administration - [See Mailbox Administration.](#)**
- # Personal Services - [See Personal Services.](#)**
- * Return to Main Menu.**

SVMi-8/SVMi-16E Subscriber Services Menu

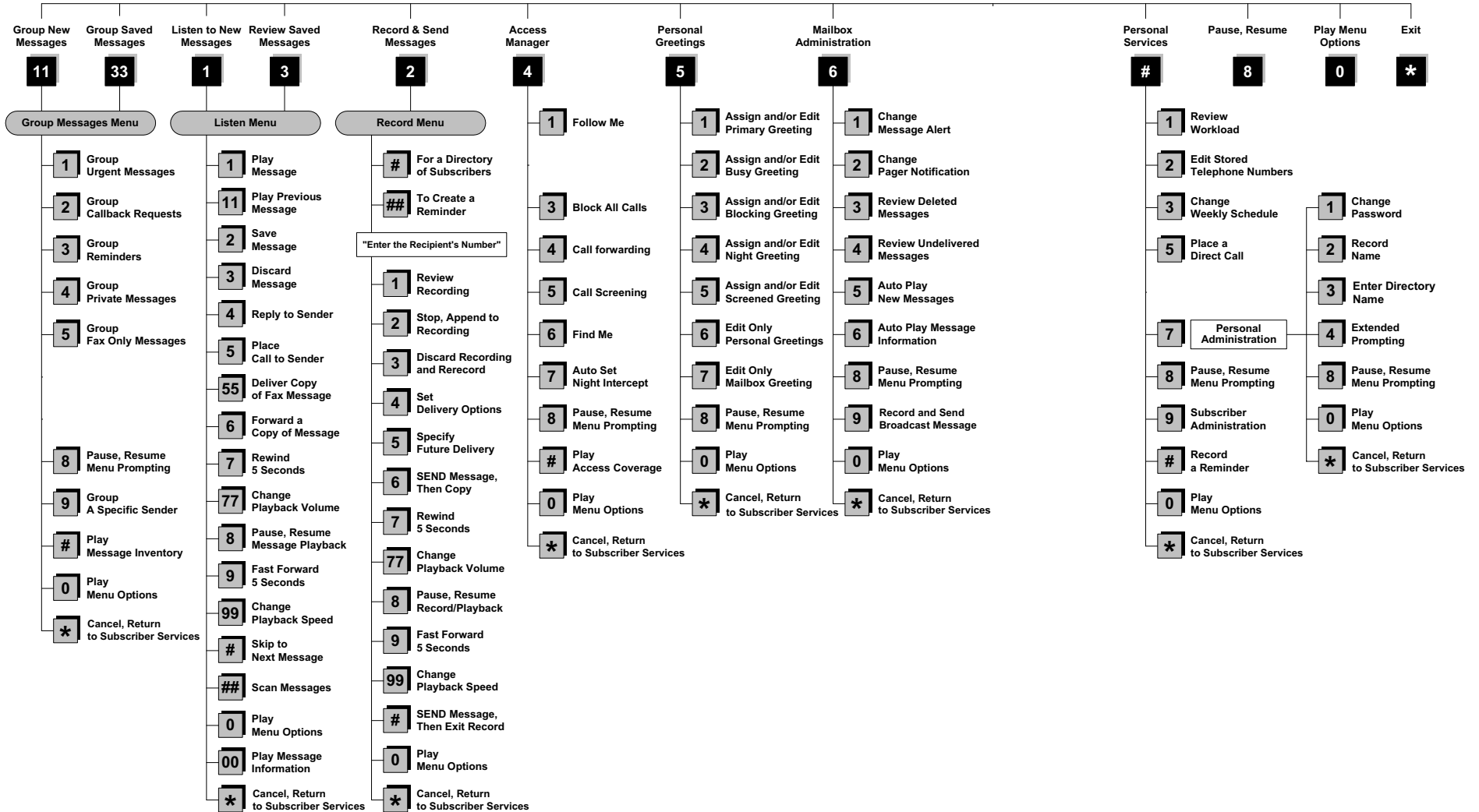

NOTE: All options shown MAY NOT be authorized. If an option is not available please speak to your system administrator.

GETTING STARTED

Using your new SVMi-8/SVMi-16E Subscriber Services is as simple as following a few simple spoken instructions. First time users should read this section as a tutorial. You should start with the following steps:

- Access your Subscriber Services Menu - You already know how to do this.

From the Subscriber Services Menu:

- Record a Primary/No-Answer Personal Greeting. Dial [5][1].
- Record a Mailbox Greeting. Dial [5][7].
- Change your access code (Password). Dial [#][7][1].
- Record your name. Dial [#][7][2].
- Enter your directory name. Dial [#][7][3].

After you have completed the steps above your Subscriber Services are set up and ready to use.

LISTEN TO YOUR MESSAGES

If there are new messages in your mailbox your [VMMMSG] key will be lit. Call the SVMi-8/SVMi-16E by pressing this key, and when prompted enter your password. You will then be at the Subscriber Services Menu. Select [1] to listen to new messages or [3] to listen to saved messages.

Note: After you enter your password, if "Autoplay of New Messages" is enabled and you have new messages the SVMi-8/SVMi-16E will begin to play them automatically. A subscriber can control this feature. From the Subscriber Services Menu [6] [5] toggles "Autoplay of New Messages" ON/OFF.

SUBSCRIBER SERVICES MENU

The following is a list of all the options available in the Subscriber Main Menu.

- 1 LISTENING TO NEW MESSAGES
- 11 GROUP NEW MESSAGES
- 2 RECORD AND SEND A MESSAGE
- 3 LISTENING TO OLD MESSAGES
- 33 GROUP OLD MESSAGES
- 4 ACCESS MANAGER
- 5 PERSONAL GREETINGS
- 6 MAILBOX ADMINISTRATION
- 8 PAUSE / RESUME

- 0 PLAY MENU OPTIONS
- * EXIT TO AUTO ATTENDANT
- # PERSONAL SERVICES

1 or **3**

LISTENING TO OLD OR NEW MESSAGES

- 1 Play / replay the message you just heard.
- 11 Play the previous message.
- 2 Save the message you just heard and listen to the next message.
- 3 Delete the message you just heard and listen to the next message.
- 4 Reply to the message.
This will allow you to leave a message in the mailbox of the sender (if the sender has a mailbox on this system).
- 5 Return the call directly to the telephone number that left the message.
This will work for internal and external callers, but Caller ID service is needed to use this feature on an outside call.
- 55 Deliver a fax copy.
This will allow you to receive attached faxmail document(s). Faxmail documents can be delivered to any fax machine of your choice as long as out calling is authorized. You can also have faxmail messages automatically delivered to the fax machine of your choice.
- 6 Forward the message and saves a copy.
The subscriber can be selected by dialing their mailbox number (nnn), using the directory service (#) or you may also add comments and leave it as a memo to yourself (##).
The Send and Copy Service (option 6) allows a user to send copies of a message to multiple recipients easily. A different introduction message may be left for each recipient.
- 7 Rewind the message 5 seconds.
- 77 Change playback volume of the recording.
There are two levels of volume during playback. Dialing this code will toggle between the two levels.
- 8 Pause or resume during message playback.
- 9 Fast forward the message 5 seconds.

- 99** Change playback speed of the recording.
There are two levels of speed during playback. Dialing this code will toggle between the two speeds.
- 0** Play options.
Pressing this key will play all the menu options available to you from this point.
- 00** Hear the time and date, and sender's information of the message you just heard. Sender information is not available on outside calls.
- #** Move to the next message. This does not Save or Discard the current message - it is retained as new.
- ##** Scan. Plays first 7 seconds of a message then skips to next message. This is similar to the scan button on a radio. It will allow you to find a specific message quickly. To stop scanning press **[1]**.
- *** Cancel and return to previous menu.

11 or **33**

GROUP NEW OR OLD MESSAGES

Messages can be grouped as either Reminders, press **[3]** or Messages from a specific sender, press **[9]**.

Additionally you can press **[#]** and hear a summary of your mailbox contents:

- a) Number of messages
- b) Number of reminders
- c) Number of urgent messages
- d) Number of messages needing a callback
- e) Number of private messages
- f) Number of fax messages

2

RECORD AND SEND A MESSAGE

This option is used to send a message to another subscriber. The steps are simple:

- a) Enter the recipient's mailbox number, or if this is not known enter **[#]** to use the system directory.

- b) Record your message at the tone. After recording the message, you will hear the Send Menu with the following functions:
 - 1** Review
 - 2** Continue Recording
 - 3** Discard and Re-Record
 - 4** Set Message Attributes (Delivery Options)
 - 5** Schedule Future Delivery
 - 6** Save and Send then Send a Copy to Someone Else
 - #** Save and Send the Recording

Setting Message Attributes

If after recording a message you select **[4]** you can set up any combination of the following delivery options:

- 1** Urgent Delivery
- 2** Return Receipt Requested
- 3** Request a Call Back
- 4** Private Delivery
- 5** Reply Required
- *** Exit

Scheduling Future Delivery

If after recording a message you select **[5]** to schedule future delivery, you will be able to set message attributes and set this message as:

- #** Immediate Delivery
 - 1** Next Few Hours
 - 2** End of Current Business Day (based on your Availability Schedule)
 - 3** Beginning of Next Business Day (based on your Availability Schedule)
 - 4** A Coming Day of the Week
 - 5** Specific Day / Time
 - *** Exit

4

ACCESS MANAGER

The Access Manager allows the subscriber to set a number of options for when, where and how, and/or if the SVMi-8/SVMi-16E contacts you when a caller dials your extension number. All of the options are toggled on/off based on their current status when you access them.

Note: ALL Access Manager options **MUST** be individually allowed by the System Administrator for each Subscriber. They are:

1 Follow Me

Allows the subscriber to enter an alternate location and set how long the new destination (Designated Location) will be active. This number may be an internal or external number. This is useful if you are frequently traveling or changing the number where you can be reached.

When Follow Me is activated, the transfer will be supervised and confirmed. This means that if the call is not answered or if rejected by the Subscriber at the designated location it will be recalled to the Subscriber's mailbox.

3 Call Blocking

When this feature is active, callers will not be transferred to your extension, they will hear your 'blocked' greeting (if recorded) and will go directly to your mailbox if they do not select any or are not offered any other options.

4 Call Forwarding

Unlike Follow Me where the subscriber wants to take their calls at an alternate location this feature allows the subscriber to pass control of his calls to another Subscriber. The "Forwarded To" Subscriber will now be in control of the caller and the caller will NOT return to originating Subscriber's Mailbox. If the "Forwarded To" Subscriber does not answer the caller it will now follow what ever the "Forwarded To" Subscriber has set up for their call conditions. The Caller will hear "Forwarding to" "{Subscriber Name}" before actually being forwarded.

5 Call Screening

If this is turned on, the caller will be asked their name and the SVMi-8/SVMi-16E will play this name to you before the transfer, giving you an option to accept or reject the call.

6 Find Me

Find Me, when enabled, will attempt to locate the subscriber by calling a list of preprogrammed phone numbers. The stored phone numbers are entered in 'Personal Services' [#][2] (if allowed by the Administrator). The stored telephone number list can contain up to 9 preprogrammed telephone numbers. The Find Me feature only use the first five.

7 Night Intercept

This feature is dependent on your weekly availability schedule, which is entered in 'Personal Services' [#][3] (if allowed by the Administrator). When Night Intercept is active the SVMi-8/SVMi-16E will first ring your extension

then play your primary, No Answer greeting during the day (when you are available) and will NOT ring your extension but simply play your Night greeting during the night (when you are not available).

Note: This does NOT use the Day and Night schedules of the phone system. It is solely controlled by the Subscriber's Availability Schedule.

8 Pause / Resume

* Exit from Access Manager

0 Play All Options

Play Access Coverage

This feature is useful for finding out how you current access settings are set. It will also tell you what greetings will play under each of the call conditions you have setup.

5

PERSONAL GREETINGS

The options available in this menu will be determined by your System Administrator, and not all of them may be available to you. In the simplest systems, only a mailbox greeting will be available, additional greetings may be accessible in more complex systems.

Your Personal Greeting will be played every time someone dials your extension and you do not answer.

You may record up to 9 Personal Greetings, and you may assign any one of them to be active. There are several different 'Call Coverage' conditions to which you may assign any of your 9 greetings. The Call Coverage Conditions are: No-Answer, Busy, and Do Not Disturb (or Forwarded All). This will allow different greetings to play depending on the type of call forward that you have set, or the condition of your telephone.

The Call Coverage conditions that you can assign specific greetings to are selected by the following digits:

1 Primary/No Answer Greeting

Used when in your office, away from your desk or during the time period you are scheduled available. If this is the only Personal Greeting you record, it will play for all call coverage conditions.

This option is available only if the Administrator has assigned you the 'Basic Greeting' feature.

Example: "Hi this is John Smith. I'm sorry I am not available to answer your call. If someone else can help you, please enter the extension number now. Or, to leave me a message, press 1."

2 Busy Greeting

Played to a caller when you are already talking to someone on your extension or the telephone at your Designated Location.

This option is available only if the Administrator has assigned you the 'Busy Greeting' feature.

Example: "Hi, this is John Smith. I'm on another line right now. If someone else can help you, please enter the extension number now. Or, to leave a message, press 1."

3 Call Blocking Greeting

Used while Call Blocking is enabled in your Access Manager or if your phone is forwarded ALL or DND.

This option is available only if the Administrator has assigned you the 'Call Blocking' feature.

Example: "Hi, this is John Smith. Sorry I missed your call, but I'm going to be out of the office for the next few hours. If someone else can help you, please enter the extension number now. Or, to leave me a message, press 1."

4 Night Greeting

Used during the time period you are scheduled UNAVAILABLE, usually after business hours during the evening and at night.

This option is available only if the Administrator has assigned you the 'Scheduling' feature.

Example: "Hi, this is John Smith. I've left the office for the evening. If you would like to try someone else, please enter the extension number now. Or, to leave me a message, press 1."

5 Call Screening Greeting

Used while Call Screening is enabled, and you REJECT a caller after listening to the caller's record name.

This option is available only if the Administrator has assigned you the 'Call Screening' feature.

Example: "Hi, this is John Smith. I'm sorry, but I am not available to speak with you at this time. If someone else can help you, please enter the extension number now. Or, to leave me a message, press 1."

6 Edit Personal Greetings

You may also edit/record each one of the greetings (1-9) at any time.

Select a greeting number to edit and follow the instructions to record your greeting. When you are done recording your greeting, you will be able to listen to the greeting you recorded, save the greeting you recorded and return to the previous menu, record the greeting again, or exit without saving the greeting.

Note: If you record only the greeting assigned to the No-Answer Call Coverage Condition, then that greeting will play to callers for all Call Coverage Conditions (No-Answer, Busy, Blocked, Night, and Rejected Caller). In this case, the salutation part of the greeting should be very general.

7 Edit Mailbox Greeting

Used whenever a caller reaches your mailbox or if you have not recorded any of the Call Coverage greetings. The way a caller is transferred to your mailbox greeting directly, is by another subscriber transferring the caller to your mailbox using the VT (VoiceMail Transfer) key.

This option is available only if the Administrator has assigned you the 'Mailbox Greeting Option' feature.

Example: "Hi, this is John Smith. Please leave me a message, I will call you as soon as I can."

Note: This greeting will only play if none of the 5 personal greetings has played to the caller. A common usage for this Greeting is when another Subscriber is talking with a caller and uses the VT key on their phone to transfer the caller directly to your Mailbox.

6

MAILBOX ADMINISTRATION

The Mailbox Administration menu is used to turn on and off your pager notification, message alert options and other message control features.

1 Message Alert

When this function is activated, the SVMi-8/SVMi-16E will call any outside or inside telephone number, after each message is left in your voice mailbox.

To hear your message at the remote location when the SVMi-8/SVMi-16E calls you, after you pick up the telephone and answer you will be instructed that there is a message and to enter your password. Simply enter your password and you will now be logged in.

Setting Up Message Alert:

- From the Subscriber Services Menu press **[6]** for Mailbox Administration.
- Press **[1]** for Message Alert.
- There are 4 options available to you:
 - Press **[1]** to toggle message alert on and off.
 - Press **[2]** to set the schedule when you would like to be notified.
 - Press **[3]** to be notified on urgent messages only.
 - Press **[4]** to set the destination phone number.

2 Pager Notification

When this function is activated, the SVMi-8/SVMi-16E will call your beeper service and notify you after each message is left in your voice mailbox.

- From the Subscriber Services Menu press **[6]** for Mailbox Administration.
- Press **[2]** for pager notification.
- There are 4 options available to you:
 - Press **[1]** to toggle pager notification on and off.
 - Press **[2]** to set the schedule when you would like to be paged.
 - Press **[3]** to be notified on urgent messages only.
 - Press **[4]** to set the pager phone number.

3 Undelete

When this function is activated, the SVMi-8/SVMi-16E will allow you to undelete any messages that you have recently deleted (up to the programmed Daily Maintenance Time, which is set to 3 a.m. by Default the following morning).

- From the Subscriber Services Menu press **[6]** for Mailbox Administration.
- Press **[3]** for Deleted Messages.

Deleted voice mail messages are temporarily stored in memory until 3 a.m. the following day. Select this option to recover ("undelete") previously deleted messages, during this period of time.

4 Undelivered Retrieval

When this function is activated, the SVMi-8/SVMi-16E will allow you to recall any messages you have sent that have NOT yet been picked up by the recipient.

- From the Subscriber Services Menu press **[6]** for Mailbox Administration.
- Press **[4]** for Undelivered Messages.

This useful feature will allow you to cancel any messages that have NOT yet been picked up by the recipient.

5 Auto Play New Messages

If this option is enabled, after you enter your password correctly any new messages will immediately begin to play. To enable (or if already enabled toggle and disable) this feature:

- From the Subscriber Services Menu press **[6]** for Mailbox Administration.
- Press **[5]** to Set Auto Play of New Messages.

6 Auto Play Message Information

If this option is enabled, the date, time and sender's name will be played automatically before each message. If this is disabled, the information must be requested manually by pressing '00'. To enable (or if already enabled toggle and disable) this feature:

- From the Subscriber Services Menu press **[6]** for Mailbox Administration.
- Press **[6]** to Set Auto Play of Message Information.

9

MESSAGE BROADCAST

This option will only be available if it has been allowed by the System Administrator.

Broadcast to All Mailboxes

If you have been designated as a Subscriber Administrator, you may send a message to ALL mailboxes in the system.

- From the Subscriber Services Menu press **[6]** for Mailbox Administration.
- Press **[9]** for Broadcast Messages.

This option will only be available if your mailbox has been assigned Subscriber Administration privileges.



PERSONAL SERVICES

The Personal Administration Menu is used to set your password and record your name. Many of these features must be allowed by the System Administrator.

1 Workload Management

Allows you to access to all reminders, both Active and Pending. If authorized you can group your reminders as Commitments, Follow-Ups or Tasks for better organization. The system will flag each reminder as Active or Pending (pending means scheduled for future delivery).

2 Stored Numbers

Allows you to enter up to 9 stored phone numbers. The first five of these are used in the 'Find Me' feature, but any of them (1-9) can be easily dialed using only one digit followed by the pound key, to be used by many other features from within your subscriber space. (ie: "Follow Me," "Message Alert," "Pager Alert," and "Direct Call").

3 Schedule Availability

Allows you to enter a weekly availability schedule for use with Night Personal Greeting and the Auto Night Intercept feature. Follow the spoken directions to enter the days of the week and times you are generally available to talk to your callers. All other times you will be considered unavailable.

5 Place a Direct Call

Allows you to place a direct call out of the SVMi-8/SVMi-16E from anywhere. You may either dial the number or dial a single digit 1-5 that corresponds to a stored number ([See Personal Services, 2 - Stored Numbers](#)). This feature must be authorized by the System Administrator and can be limited or opened to internal, local, and long distance calls.

7 Personal Administration

This area is used during the initial set up of your Subscriber Settings ([see next section](#)).

PERSONAL ADMINISTRATION SETTINGS

This menu allows you to make changes to basic setup settings, that are rarely changed. Use these when you initially set up your personal Subscriber settings. You probably will not need to change them after that.

1 Setting your Password

- From the Subscriber Services Menu press **#[7][1]**.
- The current password will be played and you will have the chance to change it.

2 Recording your Name

Use this option to record your name. Your recorded name is played in several different situations. It is important to record your name for proper operation of the SVMi-8/SVMi-16E system.

- From the Subscriber Services Menu press **#[7][2]**.
- The current name will be played and you will have the chance to change it.

Note: It is possible that if you do not record your name and/or enter your Directory Name (described below), you will not be included in the Dial by Name Directory.

3 Entering your Directory Name

Use this option to enter your Directory Name. Your Directory Name is used by callers to find you if they do not know your extension number.

- From the Subscriber Services Menu press **#[7][3]**.
- The current Directory Name will be played as a string of digits that are equal to your name spelled out on your telephone keypad. Follow the instructions to enter a new name. You will be prompted to enter your last name and then your first name.

This must be done in order for the directory feature to work correctly.

Note: It is possible that if you do not record your name (described above) and/or enter your Directory Name, you will not be included in the Dial by Name Directory.

4 Extended Prompting

Use this option to drastically reduce the number of prompts played in the subscriber interface (mailbox prompts). Change this setting only if you are very familiar with the user operation of the SVMi-8/SVMi-16E.

Note: Remember if you know what digits to press, you can enter them at any time you do not have to wait to be prompted. This feature can be toggled on/off at anytime. Also if it is off you will be prompted within each subscriber menu to press zero for more options. This enables you to still be able to find out what to do if you were to get lost and extended prompting was disabled.

KEYSET USER FEATURES

The following options are available if you have a display keyset. They require setup by the System Administrator.

Message Waiting Lights

When new messages are left in your mailbox, the voice mail message light on your keyset will flash. Press this flashing key **[VMMMSG]** and follow the prompts to retrieve messages. This key may be pressed at any time to log into your Subscriber Main Menu.

Answer Machine Emulation

If you have an Answer Machine Emulation key programmed on your keyset, you can use it to monitor calls going to your voice mail, and optionally answer them. The operation of this feature is similar to screening a call on a home answering machine.

Your keyset must be set to forward on no answer to voice mail. After ringing your station the caller will be connected to your voice mail and hear your personal greeting before leaving a message. During this time you will be monitoring the connection between the caller and your voice mail box. At this time you will only be monitoring the call, you can not talk to the other party until you answer. You may pick up the call at any time or ignore it.

To activate this feature press the **AME** button. The associated indicator will be lit steady. Press again to turn off. If this key is pressed while a station is ringing (during forward no answer), the feature will be turned on for the current call only.

While the caller is leaving a message or ringing you may:

- Press **[#]** to immediately put the caller in your voice mailbox and monitor it.
- Press **[*]** to immediately disconnect your station. The caller continues to leave a message normally.
- Pick up the handset and monitor privately.
- Press **ANS / RLS** to answer the call (using the handset or speaker).

AME Password

If your keyset has **AME PASSWORD** (MMC 110) set to **YES**, you must enter your station password to listen to messages being left. This will prevent unauthorized people from listening to messages being left for you.

If the password option is turned on, while a message is being left, press the flashing **AME** indicator and enter your station password (not your SVMi-8/SVMi-16E password). You will then hear the message being left.

Call Record

If you have a call record button assigned to your phone, you may press it at any time, to record the conversation in progress. If you have a display keyset, you will also have the soft key options to pause and time the message.

SHORTCUTS

Calling

Calling a station that is busy or does not answer you can press [#] to immediately send the call to the called parties mailbox.

Being Called

If your phone rings and you want to send the caller directly to your mailbox, simply press [#].

Direct Messaging

[#] + DSS To make it easy to leave messages for others in your office without having to dial their extension number first, keyset users may simply dial [#] plus a mailbox (extension) number and leave a message directly. If you dial a busy extension press [#] to connect directly with the mailbox.

Self Memo (Reminder)

Pressing [##] will leave a message in your own mailbox. This is useful to remind yourself of things to do now or in the future. Messages can be sent with future delivery so you can have the system call you when items become due.

INTERACTIVE DISPLAYS

Display keyset users have the added advantage of using the soft keys and displays to play, save, delete, reply, call, forward, rewind, pause, fast forward, change the volume, get message information, or help.

Viewing Mailbox Contents

If you have new messages, in addition to the Terminal Status Indicator (TSI) you will be able to use the keyset displays and soft keys to communicate with the SVMi-8/SVMi-16E.

PERSONAL SPEED DIAL NUMBERS

CODE	NAME	TELEPHONE NUMBER
00	_____	_____
01	_____	_____
02	_____	_____
03	_____	_____
04	_____	_____
05	_____	_____
06	_____	_____
07	_____	_____
08	_____	_____
09	_____	_____
10	_____	_____
11	_____	_____
12	_____	_____
13	_____	_____
14	_____	_____
15	_____	_____
16	_____	_____
17	_____	_____
18	_____	_____
19	_____	_____
20	_____	_____
21	_____	_____
22	_____	_____
23	_____	_____
24	_____	_____

PERSONAL SPEED DIAL NUMBERS

CODE	NAME	TELEPHONE NUMBER
25	_____	_____
26	_____	_____
27	_____	_____
28	_____	_____
29	_____	_____
30	_____	_____
31	_____	_____
32	_____	_____
33	_____	_____
34	_____	_____
35	_____	_____
36	_____	_____
37	_____	_____
38	_____	_____
39	_____	_____
40	_____	_____
41	_____	_____
42	_____	_____
43	_____	_____
44	_____	_____
45	_____	_____
46	_____	_____
47	_____	_____
48	_____	_____
49	_____	_____